



# Schaeffler SmartVisual

User manual

---

## Imprint

Schaeffler Monitoring Services GmbH  
Kaiserstraße 100  
52134 Herzogenrath  
Germany  
Telephone: +49 (0) 2407 9149 66  
Fax: +49 (0) 2407 9149 59  
Email: [industrial-services@schaeffler.com](mailto:industrial-services@schaeffler.com)  
Webside: [www.schaeffler.com/services](http://www.schaeffler.com/services)

All rights reserved.

No part of the documentation or software may be reproduced in any form or processed, duplicated or distributed using electronic systems without our written consent. We would like to point out that the designations and brand names of the various companies used in the documentation are generally protected by trademark, brand and patent laws.

Microsoft, Windows and Microsoft Edge are brands or registered trademarks of the Microsoft Corporation in the USA and/or in other countries. Google Chrome™ is a trademark of Google.

The software uses third-party libraries under the respective licences. For more information about the libraries used, including their licence terms, see the 'Show open source licences' option in the 'Help' menu of the SmartWeb software.

Version 1.24.0  
Translation of the original user guide.  
© 26.04.2021 Schaeffler Monitoring Services GmbH

---

# Contents

|   |           |
|---|-----------|
| <b>1 General</b> .....                          | <b>4</b>  |
| 1.1 About this guide .....                      | 5         |
| <b>2 Schaeffler SmartVisual</b> .....           | <b>6</b>  |
| <b>3 About the SmartVisual software</b> .....   | <b>7</b>  |
| 3.1 User rights and write access .....          | 7         |
| 3.2 System requirements .....                   | 7         |
| 3.3 Installing the software .....               | 8         |
| 3.4 Starting the software .....                 | 8         |
| 3.5 Editor user interface at a glance .....     | 9         |
| 3.5.1 Table list .....                          | 11        |
| 3.5.2 Device list .....                         | 11        |
| 3.5.3 Editing area .....                        | 15        |
| 3.6 Editing a project in the editor .....       | 20        |
| 3.7 Displaying a project in the Viewer .....    | 26        |
| 3.8 Settings .....                              | 28        |
| 3.8.1 Changing the language .....               | 28        |
| 3.8.2 Changing the status update interval ..... | 29        |
| 3.8.3 Setting the UDP ports .....               | 29        |
| 3.9 Further information .....                   | 30        |
| 3.10 Registering the software .....             | 31        |
| <b>4 Manufacturer/support</b> .....             | <b>32</b> |

# 1 General

The Schaeffler SmartVisual software is a plant visualisation system that enables you to view the alarm status of your Schaeffler SmartCheck or ProLink devices. The SmartVisual Editor includes a user interface that can be used to manage and view a host of visualisation tables, allowing you to visualise your entire plant and link to each area directly from the system to gain an overview of all your Schaeffler SmartCheck or ProLink devices.

## About the vibration monitoring systems

SmartCheck and ProLink are vibration monitoring systems for permanent frequency-selective monitoring. They offer you the following functionality:

**The Schaeffler SmartCheck system** can capture, record and analyse measurement values using two integrated signals and up to three connected signals. After the analysis, the system can switch outputs and display the status using LEDs depending on user-defined alarm limits. Inputs are available, which record additional signals, to allow the device to be integrated into a superordinate system. These signals can be used as command variables for a dependent signal analysis, e.g. to initiate time or event-controlled measurement jobs.

**The Schaeffler ProLink system** consists of a processor module and at least one vibration module. The system can be extended to a maximum of 4 vibration modules. Up to 4 analogue and 2 digital signals can be connected per vibration module and measured values can be logged, recorded and analysed. After the analysis, the system can switch up to 4 digital outputs per vibration module depending on user-defined alarm limits, and report the state to an external control system, for example.

The Schaeffler vibration monitoring system can be used to cover a wide range of applications; the system can be configured to meet your own requirements using the integrated SmartWeb web application. You can combine multiple SmartCheck or ProLink devices in a network. All devices are administered centrally on a PC via the SmartUtility Light software. With the full version of SmartUtility, you can also open the devices directly in the SmartWeb software, analyse measurement data in the SmartUtility Viewer and download configurations and install them on other devices.

With the SmartCheck and ProLink system, Schaeffler offers status monitoring that is optimised to suit your requirements.



## 1.1 About this guide

This guide describes how to use the Schaeffler SmartVisual software. Please read this guide carefully before using the software, and store it in a safe place.

Make sure that

- This guide is available to all users
- If the product is passed on to other users, that this guide is also passed on with it
- Additions and amendments provided by the manufacturer  are always attached to this guide.

### Further information

The Schaeffler SmartVisual software is optional component of the Schaeffler SmartCheck or ProLink vibration monitoring system. This system also includes the Schaeffler SmartCheck or ProLink device and the Schaeffler SmartUtility Light software, each of which is described in its respective manual.

Optionally, instead of the Schaeffler SmartUtility Light software, you can purchase the Schaeffler SmartUtility software with enhanced functionality. This is also described in a separate manual.

### Definitions

- Product: the Schaeffler SmartVisual software described in this manual.
- User: person or organisation capable of putting the product into operation and using it.

### Symbols used



This symbol indicates

- Helpful additional information and
- Settings or practical tips that will help you to perform activities more efficiently.

Cross-reference symbol : This symbol refers to a page in the manual that provides further information. If you are reading the manual in PDF format on screen, clicking the word to the left of the cross-reference symbol will take you straight to the section in question.

## 2 Schaeffler SmartVisual

The SmartVisual software is made up of the following components:

### SmartVisual Software

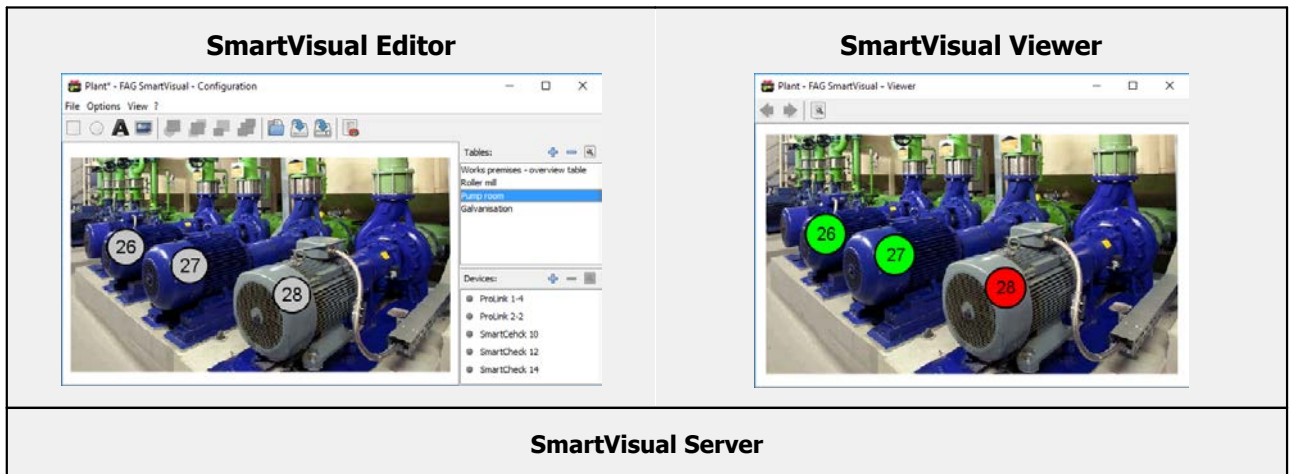

- **SmartVisual Editor:** Here, individual tables can be edited to create a complete visualisation of the plant - from the site plan, to the machine hall, to the individual machines. It can also be used to position elements containing links to the SmartCheck or ProLink devices.
- **SmartVisual Viewer:** This component allows the user to scroll through the individual tables. The alarm status of the elements linked to SmartCheck or ProLink devices is displayed here. Double-clicking on a device element will open the device in the browser.
- **SmartVisual Server:** This service runs in the background and regulates communication.

## 3 About the SmartVisual software

The SmartVisual software is provided to you as a setup version that you need to install. You can find this version in the "SmartVisual" program directory on the supplied CD-ROM. The setup version automatically checks the requirements for using the SmartVisual software and installs the relevant elements as required.

### 3.1 User rights and write access

To install and operate the SmartVisual software, you require special access rights. Please contact your system administrator if you experience problems with the security requirements of your system.

#### User rights

To install the SmartVisual software, you require administrator rights on your system.



Tip: Install the software with administrator rights and then switch back to a normal user.

#### Write access

The software saves settings data and log data during operation. For this reason, you require write access for the following directories for the setup version of the SmartVisual software:

##### Program files

C:\Programme\FAG\SmartVisual

##### Configuration and settings files

C:\Benutzer\[Benutzername]\AppData\Roaming\FAG\SmartVisual

### 3.2 System requirements

Your system needs to meet the following requirements for you to get the most from your SmartVisual software:

#### General system requirements

Windows 10 (32/64 Bit)

The system requirements recommended by Microsoft must be met as a minimum:

- Dual-core processor
- 2 GB RAM (recommended: 4 GB RAM)
- 16 GB of hard disc space available
- DirectX 11-compatible graphics device

In addition:

- Screen resolution: 1024x768 (pixels) at 96 dpi and normal font size (recommended: 1280x800 or higher)
- Disk space for software: at least 20 MB free disk space
- Mouse: three-button mouse recommended

#### Other requirements

- Microsoft .NET Framework 4.6.1
- Standard browser: Google Chrome, Microsoft Edge
- Java Runtime Engine 1.6
- Windows Installer 4.5

### Requirements for connection to the computer

- The communication protocol TCP must be enabled on port 80 and the UDP communication protocol enabled on ports 19002 to 19003 used in existing firewalls in your network. The UDP port numbers can be set [29] in the settings for the SmartVisual software.
- The proxy setting in Internet Explorer must be set to "Automatic search".
- If the SmartCheck or ProLink device has not been assigned an address via DHCP, it will have the IP address 192.168.1.100 by default. In this case, the IP address of your computer must be within the 192.168.1.x range.

Please contact your system administrator if you experience problems with the network settings.

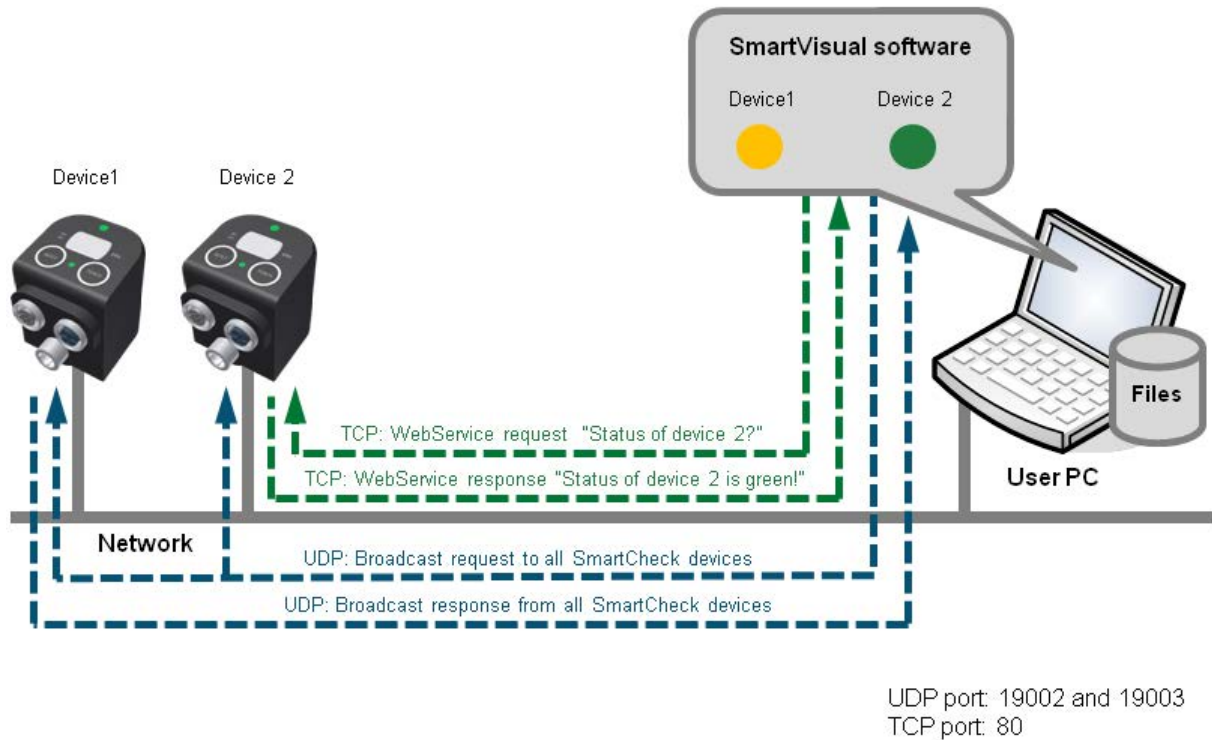

*Standard way in which the SmartVisual software communicates - here with the SmartCheck devices*

### 3.3 Installing the software

Open the SmartVisual program directory on the supplied CD-ROM. Double-click on the file **Setup.exe**. This starts a wizard, which will guide you through the individual installation steps. This includes - depending on your system configuration - the following steps:

- **Select target directory:** You can either accept the suggested directory or enter a different directory. The Schaeffler SmartVisual software is saved in the following directory by default:  
C:\Programs\FAG.
- **Select components:** Here you can specify whether the handbooks are to be installed and shortcuts pinned to the Start menu or desktop.
- **Select folder in start menu:** This option allows you to adjust the SmartVisual entry in the Start menu to your preferences.

Depending on the option you select, shortcuts that you can use to start the SmartVisual software will be added to the Start menu and desktop during the installation process. Once the installation process is complete, the software can be started from the wizard by activating the **Run SmartVisual** checkbox.

### 3.4 Starting the software

You can start the SmartVisual software via links in the Start menu and on the desktop. When the software is started for the first time, the **SmartVisual Editor** opens. Using the Editor, the individual tables can be edited and SmartCheck or ProLink devices added to them. The tables can then be viewed in the SmartVisual Viewer. When Schaeffler SmartVisual is



started, a SmartVisual server instance is automatically started too. This will run in the background for the entire time the software is in use.

### 3.5 Editor user interface at a glance

The user interface for the SmartVisual Editor can be broken down as follows:

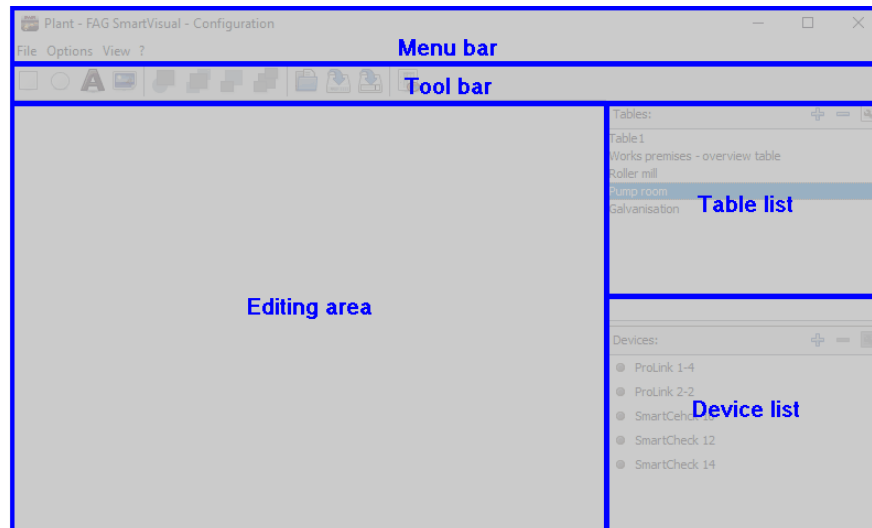

The user interface offers you these options:

#### Menu bar

The following options can be found in the menus:

##### Project

- **New:** This command is used to create a new project. If you have not yet saved any changes made to the project currently in use, you will be prompted to do so.
- **Open:** This command is used to open an existing project.
- **Recent projects:** Projects recently opened in the SmartVisual software are displayed here. By clicking on the links in this list, you can gain rapid access to the projects in question.
- **Save:** This command is used to save a project under a file name and storage location defined by you.
- **Save as:** This command is used to save a project under a file name and storage location defined by you. If you are saving a project for the first time, the **Save as** dialog box is displayed automatically if you click on **Save**.
- **Close:** This command is used to close SmartVisual. The SmartVisual server remains active and is displayed as a symbol on the task bar. To also exit the SmartVisual server, right-click on the symbol and select "Exit SmartVisual server".

##### Settings

- **Load recently used project automatically on startup:** If this option is activated, the most recently used project is automatically opened on startup.
- **Start SmartVisual Viewer with current table:** If this option is activated, the SmartVisual Viewer opens displaying the table that is currently selected.
- **Show recently used table automatically:** If this option is activated, the SmartVisual Viewer automatically shows the most recently used table on startup.
- **Language:** <sup>28)</sup> This option is used to define the language in which the SmartVisual software interface is to be displayed.
  - **Select language:** The following languages can be selected by default: German and English.
  - **Export/import language file:** Here you have the option of exporting the language file in CSV format and adding another language. Once you have translated the text, you can import the language file again. The new language is displayed the next time the program is started.
- **Status update interval:** <sup>29)</sup> Here you can define the intervals at which the alarm status of the SmartCheck or ProLink devices in the SmartVisual Viewer is queried.

- **Set UDP ports:**  Here you can set the UDP ports for the device search and device configuration.

## View

- **Start SmartVisual Viewer:** This command starts the SmartVisual Viewer that is used for executing projects created in the SmartVisual Editor.

?

Here you can find detailed information about the **version** of the SmartVisual software, including the option to register for the 60-day test version.

## Tool bar

In the tool bar, you will find the drawing functions for the plant visualisation, as well as shortcuts to the most frequently used menu items:



**Add rectangle:** Creates a rectangle or square.



**Add ellipse:** Creates an ellipse or a circle.



**Add text:** This option allows you to add text.



**Add image:** This option allows you to add a site plan or photo as a background image and mark the position of the SmartCheck or ProLink devices.



**Bring element one layer forward:** This option allows you to move an image you have added or individual objects one layer forward.



**Bring element to front:** This option allows you to bring an image you have added or individual objects to the front.



**Bring element one layer backward:** This option allows you to move an image you have added or individual objects one layer back.



**Bring element to background:** This option allows you to move an image you have added or individual objects to the background.



**Open:** Click on this button to open a saved project.



**Save:** Click on this button to save the project currently in use.



**Save as:** Click on this button to save the project currently in use in a different directory or under a different name.



**Go to SmartVisual Viewer:** Click on this button to display the project currently in use in the SmartVisual Viewer.

## Table list

Here you can create several tables containing hall plans or images for each project.

## Device list

Here you can view the SmartCheck or ProLink devices you have added to a project.

## Editing area

Here you can edit the individual tables, e.g. add a hall plan or photo as a background image and mark the positions of the SmartCheck or ProLink devices.



You can use the separator between the table and device areas to adapt the interface of the SmartVisual software to suit your requirements:

- Holding down the left mouse button, drag the separator up or down to alter the size of the relevant area.

### 3.5.1 Table list

Using SmartVisual, you can visualise multiple plant tables and establish links between them. For instance, using this software, a table with a site plan can be created, which can be used to call up the individual halls containing the plants and SmartCheck or ProLink devices.

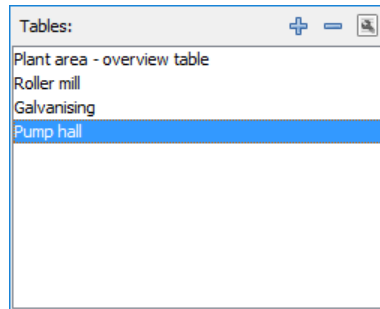

#### Adding a table

- Click on **+** to add more tables to the project.

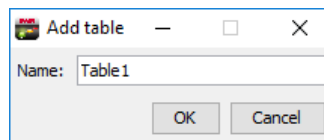

- If necessary, change the **name** of the table.
- Click on **OK**.

#### Editing a table

- Double-click on an entry in the **Tables** area.
- Or:
- Select a table from the **Tables** area.
  - Click **Edit**  in the tool bar.
  - Give the table a clear name (e.g. "Pump room").
  - Click on **OK**.

#### Removing a table

If a table is no longer required, it can be removed from the list by highlighting the table and clicking **Delete** . The table is deleted.

### 3.5.2 Device list

In the device list, you can add the SmartCheck or ProLink devices that you wish to monitor using the SmartVisual software.

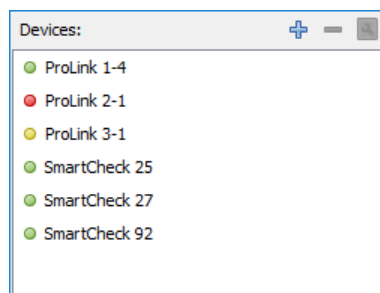

## General

The procedure differs depending on whether all devices are in the same network in the same IP range or whether there is a router in between.

### SmartCheck or ProLink Devices in the same network

If the computer is located in the same network as the SmartCheck or ProLink devices, these devices will automatically be displayed in the device list.



Different ports are used to search and configure devices. If you are using the SmartUtility (Light) software in parallel, different UDP ports must also be used for this software to avoid port conflict. The ports are configured as follows by default:

|   | SmartVisual | SmartUtility (Light) |
|---|-------------|----------------------|
| <b>UDP port for device search:</b>        | 19002       | 19000                |
| <b>UDP port for device configuration:</b> | 19003       | 19001                |

These automatic settings are generally correct. If necessary, you can change the ports in the Settings  option in the software. If there are any problems, please contact your system administrator.

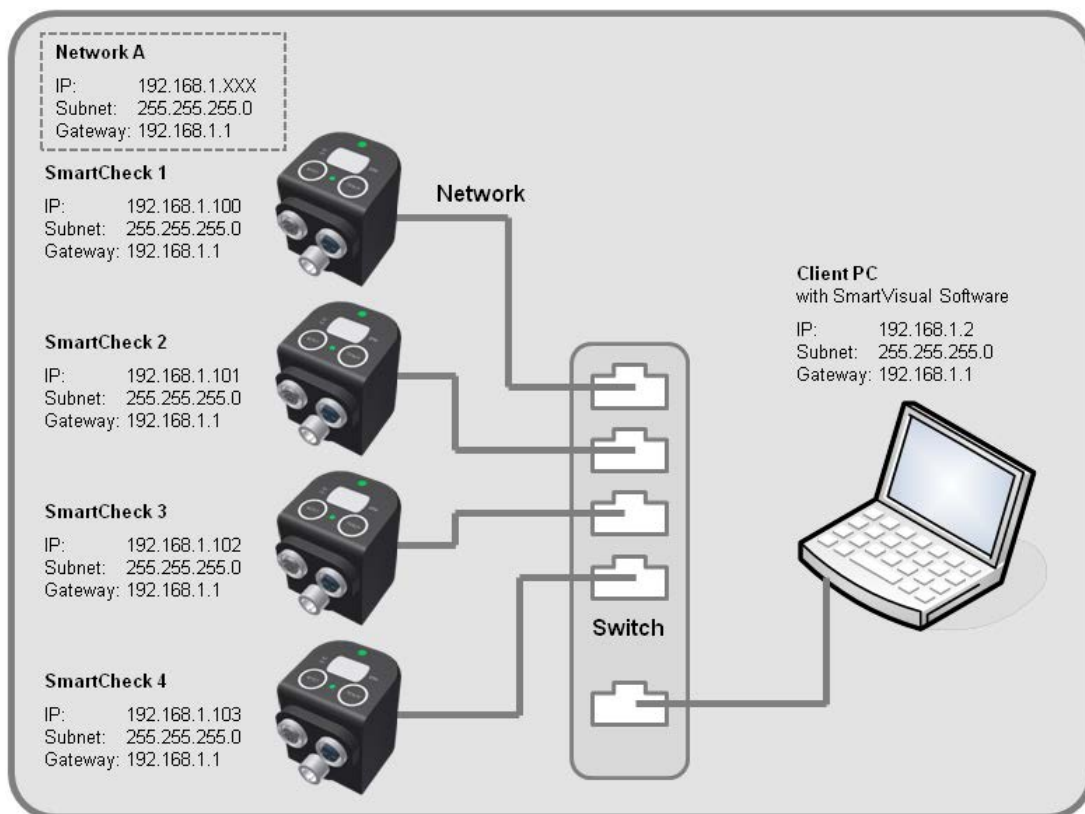

Example with SmartCheck devices

### SmartCheck or ProLink devices outside the network

If the computer is located in a different network to the SmartCheck or ProLink devices, the devices must be added manually. This is because the router filters out the UDP broadcast.

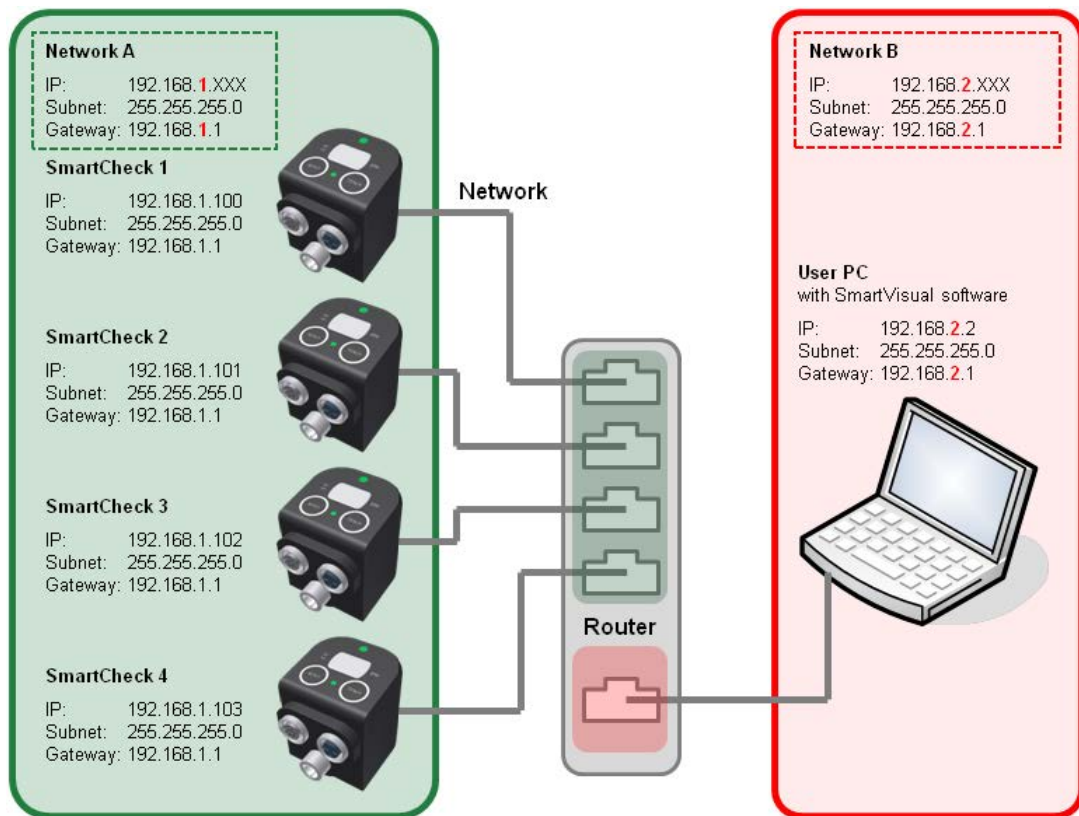

Example with SmartCheck devices

The process for adding devices manually is covered in the section entitled [Adding SmartVisual devices manually](#) <sup>14</sup>.

## Adding devices

- Click on **+** to add more devices to the project.

All the SmartCheck or ProLink devices found in the network are displayed in the list:

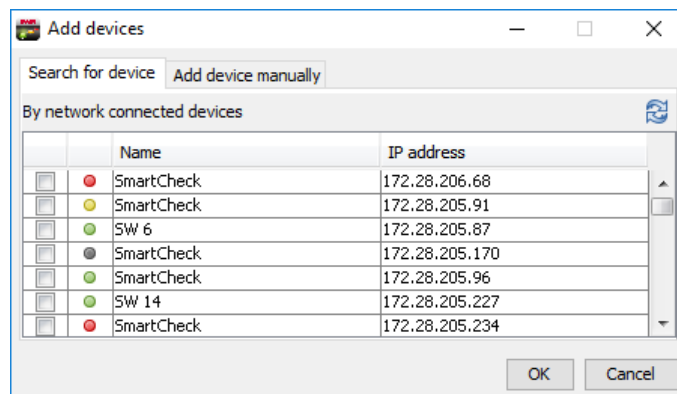

The following information and functions are to be found here:

- The columns in the list provide information on the alarm status, name and IP address of the individual devices.
- The alarm symbols show you at a glance:
  - Green: There is no alarm
  - Yellow: One or several characteristic values have triggered a pre-alarm
  - Red: One or several characteristic values have triggered a main alarm
  - White: The alarm status is still unknown, e.g. because the device has not yet carried out any measurements.
- The alarm symbols are updated on a regular basis.
- You can adjust the column width.



If the list does not contain any entries or a device is missing, you can update the list. To do so, click on **Refresh**  or add the device manually (see below). If there are still no devices displayed, make sure:

- that the device is in measuring mode and connected to the network;
- that you are connected to the network;
- that the UDP port  settings in the SmartVisual software are correct.

### Select devices

You have the option of adding one or more devices that you would like to position in the tables to the device list. To do so, activate the checkbox in the list  in front of the appropriate device name.

### Updating the device list

You can update the list of SmartCheck or ProLink devices by clicking **Delete** .

### Adding devices manually

If you cannot find a SmartCheck or ProLink device in the list of available devices, or the device is not located in the same network, you can also add it manually. To do so, click on the **Add devices manually** tab:

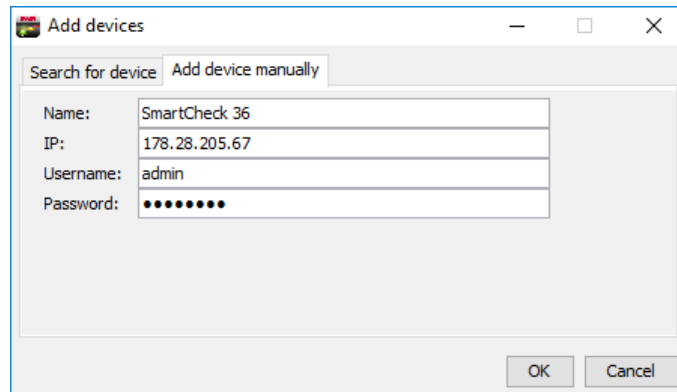

The screenshot shows a dialog box titled "Add devices" with two tabs: "Search for device" and "Add device manually". The "Add device manually" tab is active. It contains four input fields: "Name:" with the text "SmartCheck 36", "IP:" with "178.28.205.67", "Username:" with "admin", and "Password:" with a masked password of seven dots. At the bottom right, there are "OK" and "Cancel" buttons.

Here you have the following options:

- Specify a **name** to be used to indicate the device in the device list.
- Enter the **address** (IP address) of the SmartCheck or ProLink device.
- If the device is password-protected, specify the **user name** and **password**.
- Click on **OK**.



Further information on the password protection of SmartCheck or ProLink devices can be found in the **User management** chapter in the Schaeffler SmartWeb user documentation.

### Editing a device

- Double-click on an entry in the **Devices** area.

Or:

- Select a device from the **Devices** area.
- Click **Edit**  in the tool bar.
- Edit the name, IP address and password information.
- Click on **OK**.

### Remove device

If a device is no longer required, it can be removed from the list of devices by highlighting the device and clicking **Delete** . The device is removed from the device list in the SmartVisual software.

### 3.5.3 Editing area

In the editing area of the SmartVisual Editor, the individual tables can be edited and SmartCheck or ProLink devices can be positioned. For example, a site plan could be added and used to link the individual halls with the plants and devices.

The following visualisation elements are available in the editing area:



- **Adding rectangular or elliptical elements** <sup>[15]</sup>
- **Adding and editing text** <sup>[16]</sup>
- **Adding images** <sup>[16]</sup>
- **Deleting elements** <sup>[17]</sup>
- **Linking elements** <sup>[17]</sup>



- The size of images and elements can be scaled horizontally, vertically or proportionally. For example, to scale an image proportionally, click on a corner of the image using the left mouse button, hold the Shift key down and drag the image to the required size. Using the Ctrl key, an object can be scaled over a fixed midpoint.
- When new images or elements are added, these elements are always positioned in the foreground. The "Bring element one layer backward" tool in the tool bar <sup>[10]</sup> can be used to move certain elements one layer back, for example, if required.
- If you wish to move an element, simply highlight it and, keeping the left mouse button held down, drag it to the required position. Several elements can be moved at once by using the mouse to highlight all of the elements you wish to move.

#### Adding rectangular or elliptical elements

Rectangular or elliptical elements can be used to visualise hall plans or the position of the SmartCheck or ProLink devices.

- Click on **Add rectangle**  or **Add ellipse**  in the tool bar.

The element is automatically positioned in the foreground.

- Move the element to the required position.

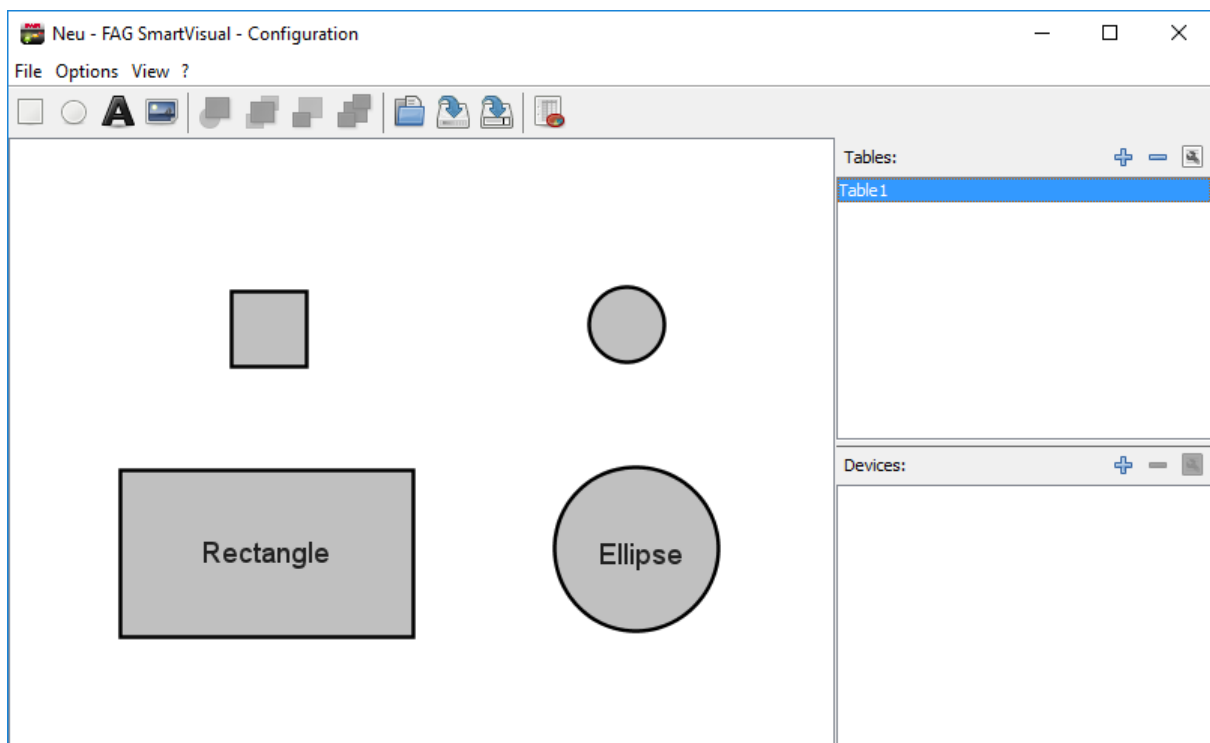

---

## Adding and editing text

Text can be added to clearly identify the individual elements of the table.

### Adding text

- Click on **Add text**  in the tool bar.

The text element "Text" is automatically positioned in the foreground. By highlighting the text element and clicking the "Delete" key, you can delete the example text and add new text.

### Editing text

- Double-click on the text element.
- In the **Edit element** dialog box, click on the **Text** tab.

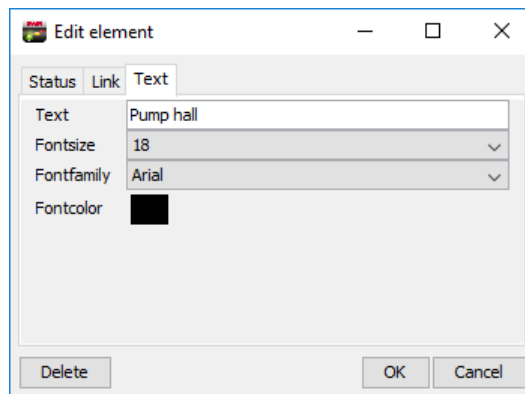

- Enter the required text (e.g. "Hall 1").  
You also have the option of adjusting the font, font size and/or font colour.
- Click on **OK**.
- Move the text element to the required position.

## Adding images

Images or graphic representations of your plant can be added, to visualise the position of the individual SmartCheck or ProLink devices, for example.

- Click on **Add image**  in the tool bar.
- Select a photo or graphic representing your plant. The image must be in one of the following formats: JPG, BMP or PNG.
- Click on **Open**.

The image is automatically positioned in the foreground.

- Move the image to the required position.



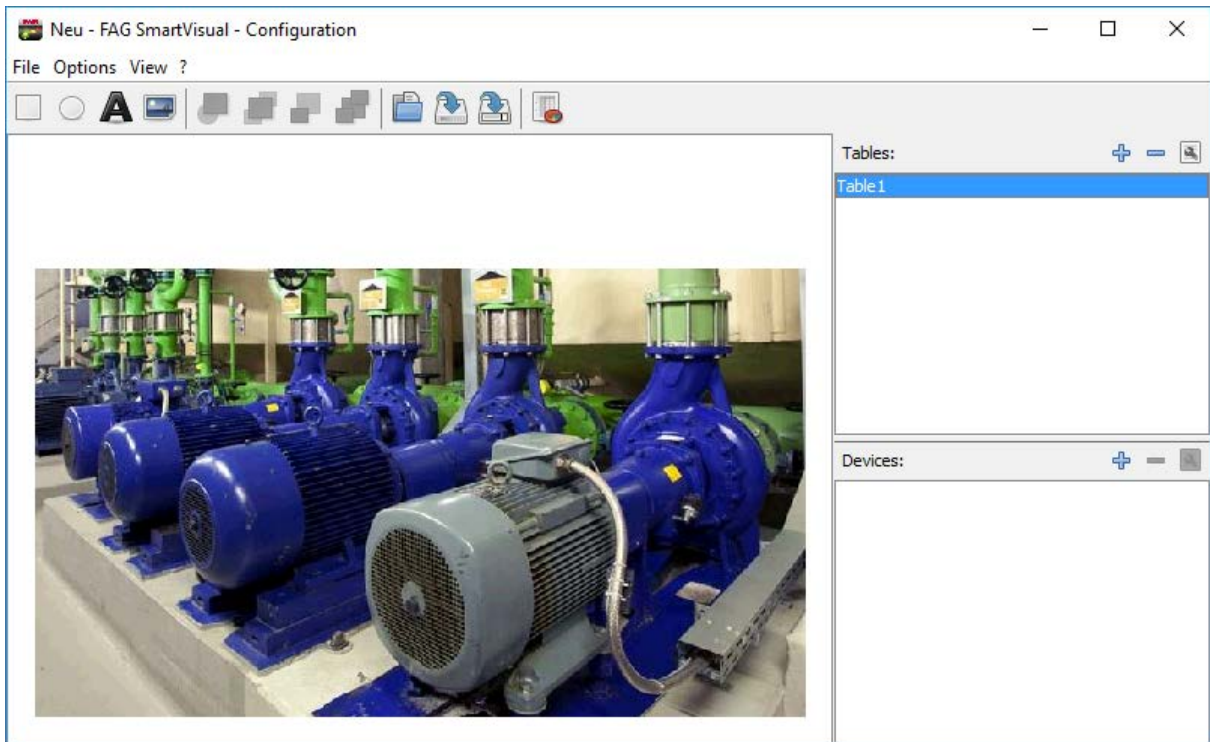

### Deleting elements

- Highlight the element that you wish to delete from the table.
  - Press the **Delete** key.
- Or:
- Double-click on the element that you wish to delete.
  - In the **Edit element** dialog box, click **Delete**.

### Linking elements

Each element can be linked to another table and/or a device. In this way, a site plan containing several halls can easily be visualised, as can the overall alarm status of the SmartCheck or ProLink devices in the halls.

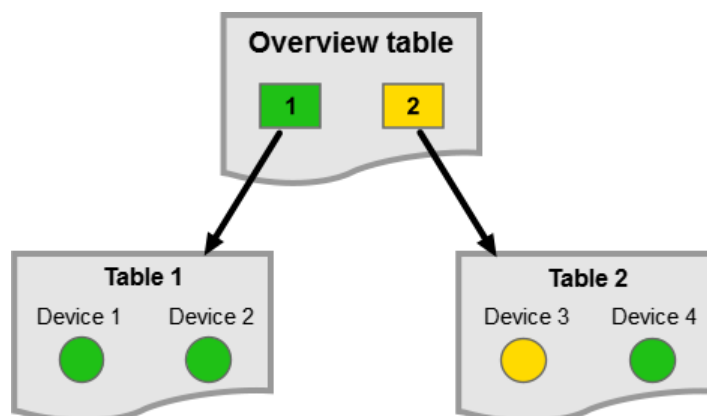



- In order to better differentiate between the individual elements, it is recommended to use elliptical elements for linking to SmartCheck or ProLink devices and rectangular for linking to tables.
- If an element links to the alarm status of a table containing several SmartCheck or ProLink devices, the overall alarm status will always be displayed; in other words the consolidated alarm status of all devices.
- Text elements and images cannot display the alarm status of a device. Please only use rectangular or elliptical elements to display the alarm status.

### Linking an element to a device

Link an element to a device in order to display the alarm status of the SmartCheck or ProLink device.

- Double-click on the element that you wish to link.

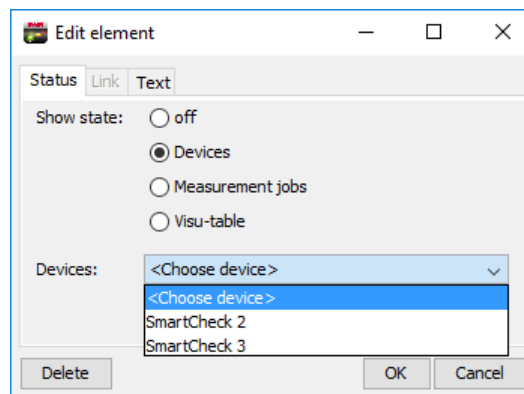

- In the **Edit element** dialog box, click on **Status**.
- Select **Devices** and
- select a device from the list.
- Click on **OK**.

The element is now linked with the SmartCheck or ProLink device. The alarm status of the device will only be displayed when viewing the table in the SmartVisual Viewer.

### Linking an element to measurement jobs

Link an element to one or more measurement jobs of a SmartCheck or ProLink device in order to display the alarm status of measurement jobs.

- Double-click on the element that you wish to link.

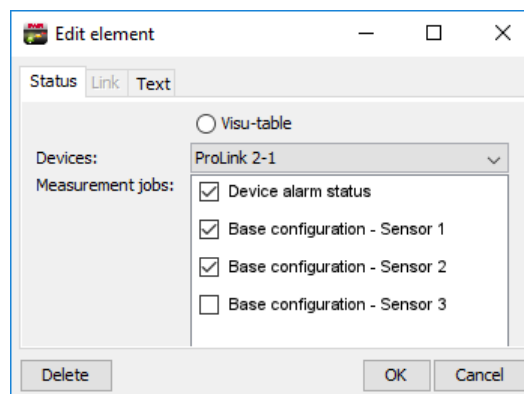

- In the **Edit element** dialog box, click on **Status**.
- Select **Measurement jobs**.
- Select the **device** whose measurement jobs you want to link.
- Check the box in front of the desired measurement jobs.

- Click on **OK**.

The element is now linked with the desired measurement jobs of the SmartCheck or ProLink device. The alarm status of the device will only be displayed when viewing the table in the SmartVisual Viewer.

### Linking an element with another table

The overall alarm status of another table can be displayed by linking an element to that table.

- Double-click on the element that you wish to link.

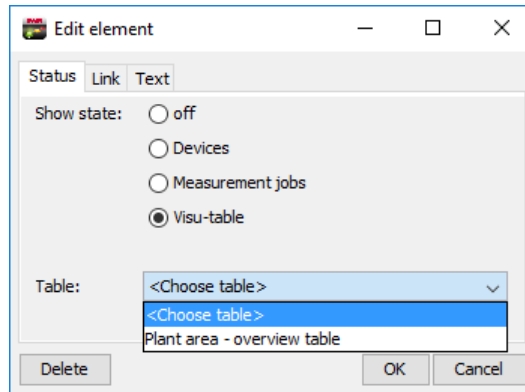

- In the **Edit element** dialog box, click on **Status**.
- Select **Visualisation table** and
- select a table from the list.
- Click on **OK**.

The element is now linked with the table. The alarm status of all the SmartCheck or ProLink devices in the linked table will only be displayed when viewing the table in the SmartVisual Viewer.



If you just wish to link to another table without displaying the alarm status, click on **Link** in the **Edit element** dialog box and select a table. In this way, an element containing a link to an overview table can be added, or a Home button can be created.

## 3.6 Editing a project in the editor

When starting the SmartVisual software for the first time, an empty project is displayed. You can then start editing the first table by adding a general plan, a ground plan or a photo and marking the positions of the individual SmartCheck or ProLink devices.

The following example describes how to set up a plant visualisation with a hall plan, and from there establish links with the SmartCheck or ProLink devices in the individual halls:

1. **Configuring an overview table** [101](#)
2. **Adding and configuring further tables** [102](#)
3. **Positioning devices** [103](#)
4. **Linking devices** [104](#)
5. **Linking tables** [105](#)
6. **Saving a project** [106](#)

The result will look something like this:

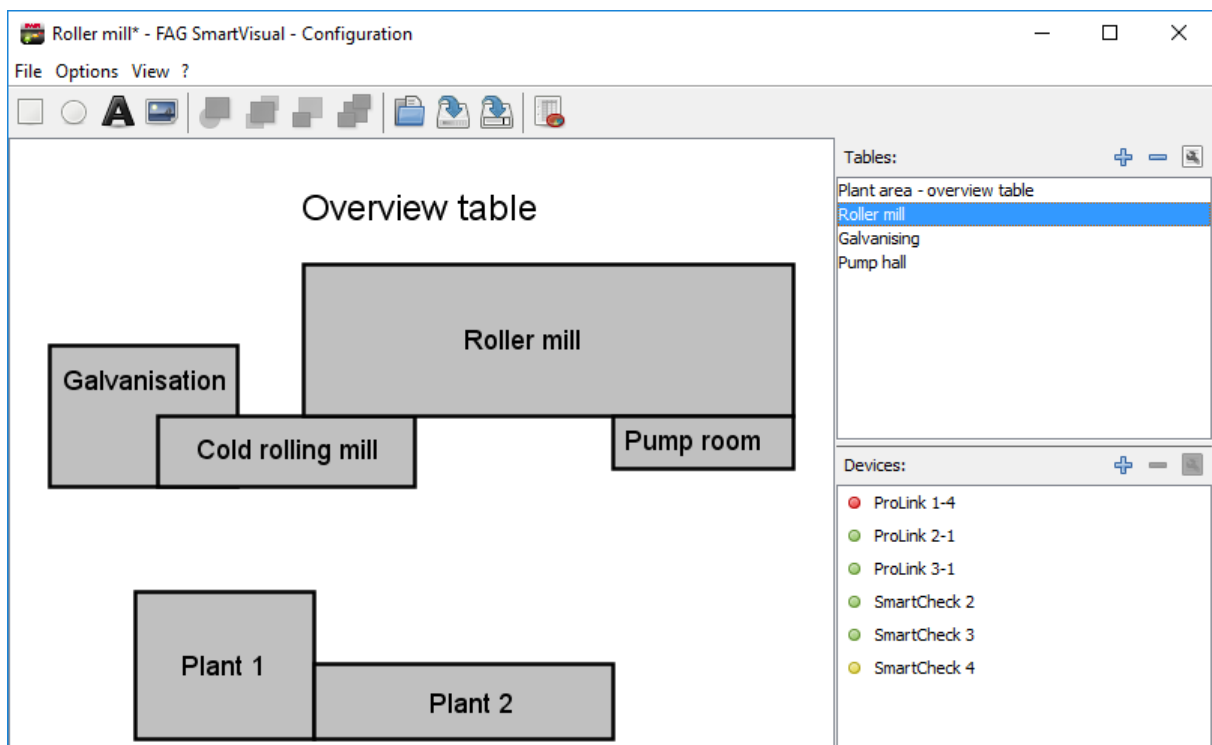



### 1. Configuring an overview table

If you use multiple SmartCheck or ProLink devices in different halls, you must first create a plan of your works premises in the form of an overview table. To do so, create a rough drawing of the halls using rectangular or elliptical elements and label the halls accordingly.



- A photo of your works premises can be used as a template. To do so, click "Add image" in the tool bar  and use the tools [101](#) to position it in the background.
- The size of images and elements can be scaled horizontally, vertically or proportionally. For example, to scale an image proportionally, click on a corner of the image using the left mouse button, hold the Shift key down and drag the image to the required size. Using the Ctrl key, an object can be scaled over a fixed midpoint.
- When new images or elements are added, these elements are always positioned in the foreground. The "Bring element one layer backward" tool in the tool bar can be used to move certain elements one layer back, for example.

### Adding rectangular or elliptical elements

- Click on **Add rectangle**  or **Add ellipse**  in the tool bar.
  - Adjust the size and position of the element.
- The element is automatically positioned in the foreground.
- Move the element to the required position.

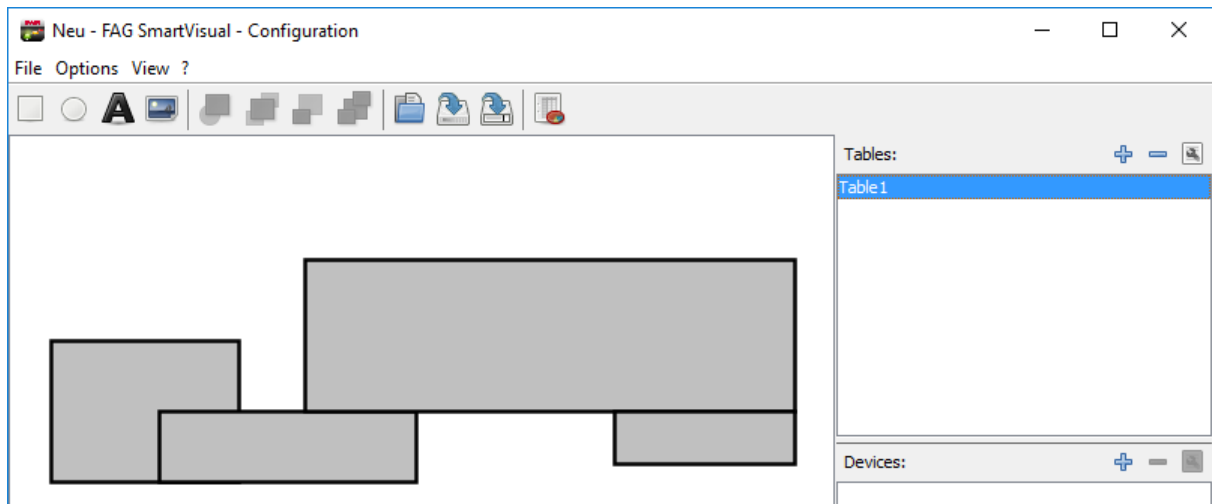

### Labelling elements

Text can also be added to identify elements:

- Click on **Add text**  in the tool bar.
- Double-click on the text element.
- In the **Edit element** dialog box, click on the **Text** tab.

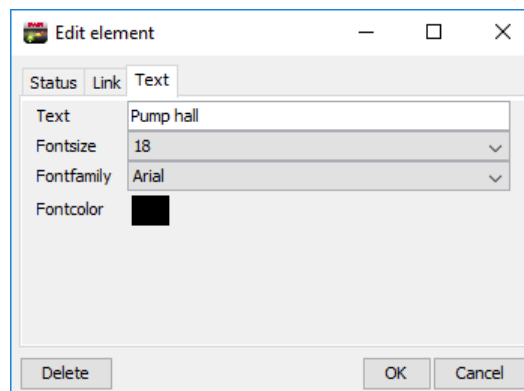

- Enter the relevant text (e.g. "Roller mill").  
You also have the option of adjusting the font, font size and font colour.
- Click on **OK**.
- Move the text element to the required position.

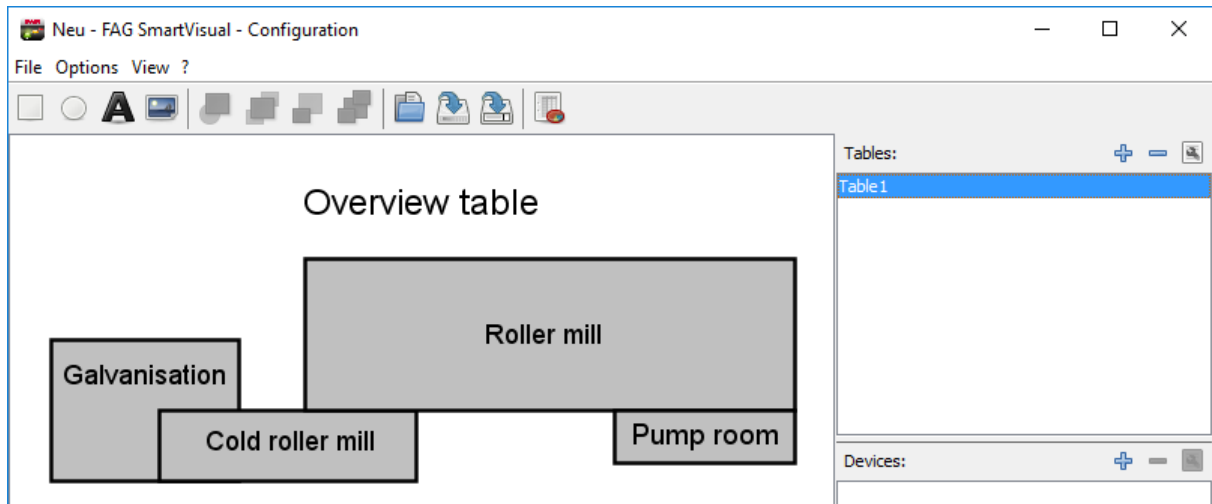

### Renaming a table

Now rename "Table 1":

- Select the entry "Table 1" from the **Tables** section.
- Click **Edit**  in the tool bar.
- Give the table a clear name (e.g. "Works premises - overview table").
- Click on **OK**.

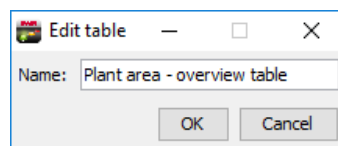

## 2. Adding and configuring further tables

Now set up a new table for the pump room and create a plant visualisation using rectangular or elliptical elements, or using an image.

- Set up a new table by clicking on **Add** in the  **Tables** section.
- Give the new table a name (e.g. "Pump room").

Configure the plant using elements or add an image:

- Click on **Add image**  in the tool bar.
- Select an image, e.g. a photo of the plant. The image must be in one of the following formats: JPG, BMP or PNG.
- Click on **Open**.

The image is automatically positioned in the foreground.

- Move the image into the required position.

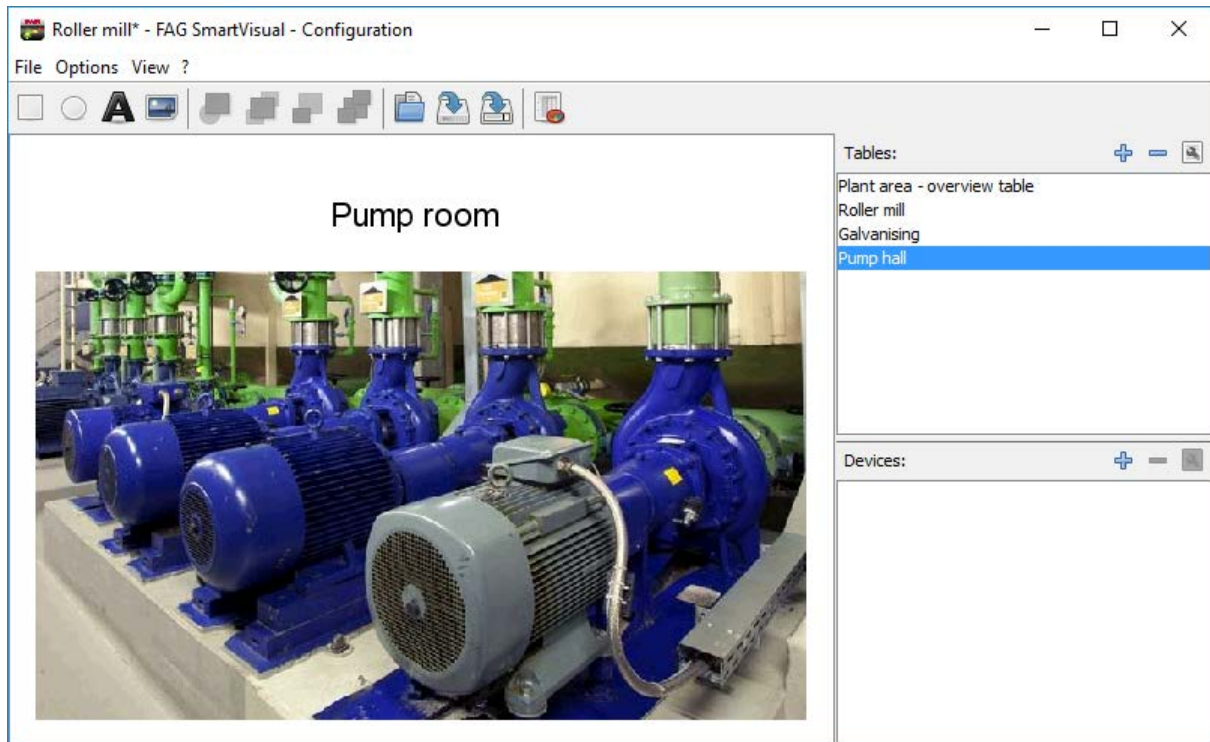

There are no restrictions on the number of tables containing visualisation elements you can create. The next steps explain how to position the individual SmartCheck or ProLink devices and link visualisation tables together.

### 3. Positioning devices

The position of the individual SmartCheck or ProLink devices can now be marked in the table using rectangular or elliptical elements, and the devices labelled accordingly.

- To do so, click on **Add ellipse**, for example.
- Click on the ellipse and, keeping the mouse button held down, drag it to the required position.

Text can be added to label the elements:

- Click on **Add text**.
- Double-click on the text element.
- In the **Edit element** dialog box, click on the **Text** tab.

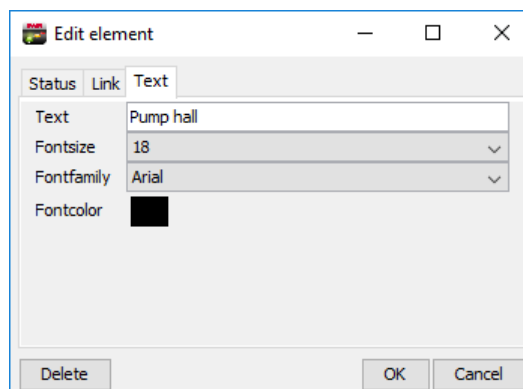

- Enter the relevant text (e.g. "26" for SmartCheck or ProLink device 26). You also have the option of adjusting the font, font size and/or font colour.
- Click on **OK**.

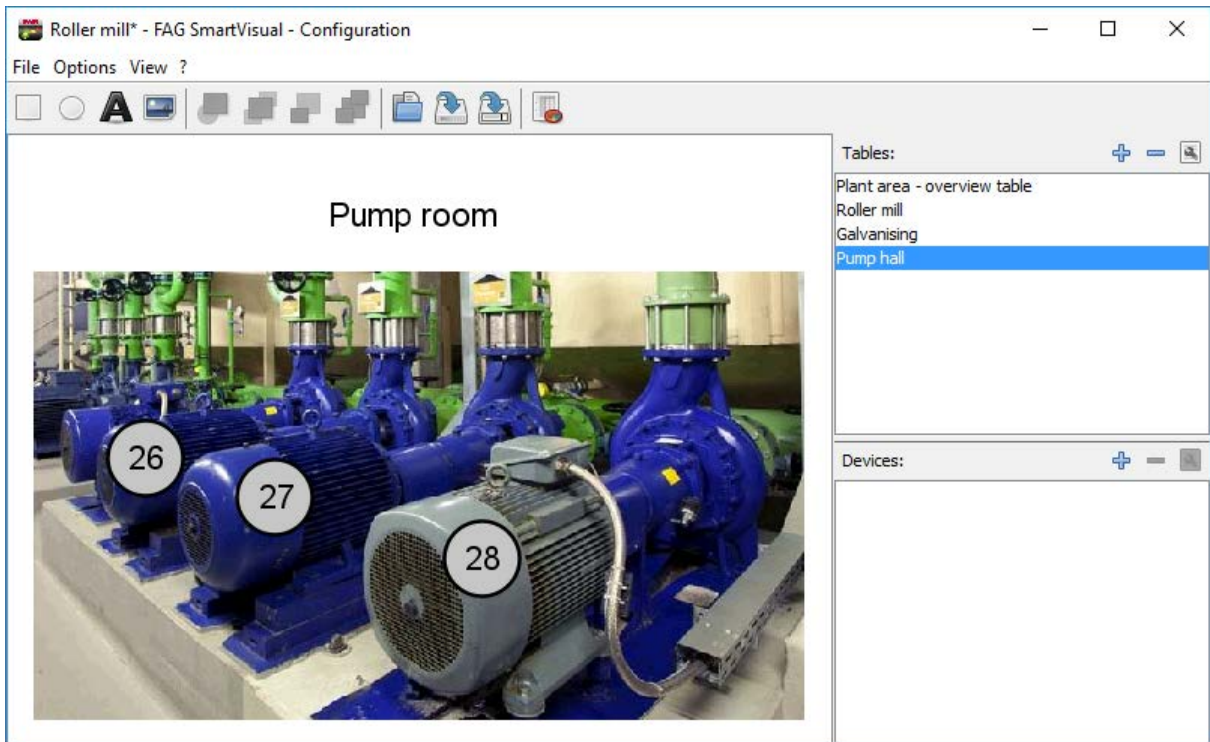

Text elements and images cannot display the alarm status of a SmartCheck or ProLink device. Please only use rectangular or elliptical elements to display the alarm status.

#### 4. Linking devices

The elements that visualise the SmartCheck or ProLink devices can now be linked to the individual devices.

- To do so, double-click on an elliptical or rectangular element.
- In the **Edit element** dialog box, click on the **Status** tab.

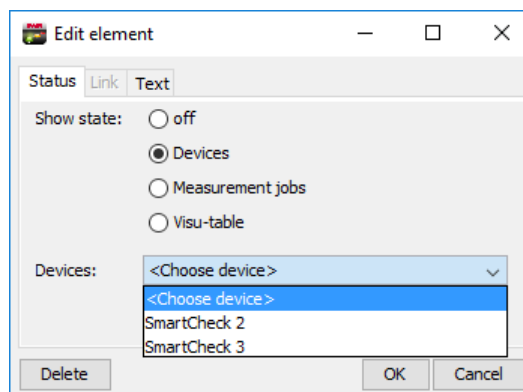

- Select **SmartCheck or ProLink** under "Show state" and
- select the corresponding SmartCheck or ProLink device from the list.
- Click on **OK**.

The element is now linked with a SmartCheck or ProLink device. If using the SmartVisual Viewer, the alarm status of the SmartCheck or ProLink device is displayed automatically.



Alternatively, you can also link individual measurement jobs  of a SmartCheck or ProLink unit.



## 5. Linking tables

If you want to link to the hall plan from the plant overview using the SmartCheck or ProLink devices, and thus display the alarm status of the devices in the overview plan, this can be configured in the **Edit element** dialog box.

- To do so, double-click on an elliptical or rectangular element.
- In the **Edit element** dialog box, click on the **Link** tab.

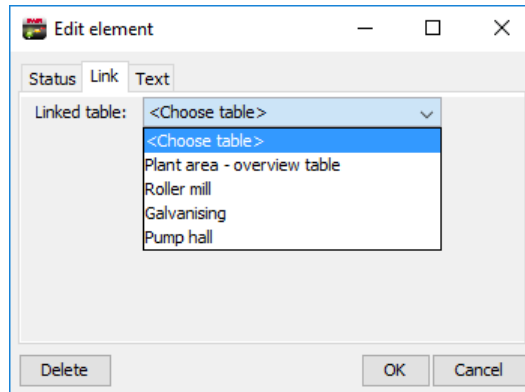

- Select a table from the list.
- Click on **OK**.

The individual tables are now linked with one another. Using the SmartVisual Viewer, it is possible to automatically switch between the various tables.

## 6. Saving a project

- Select **File > Save as** or click on  in the tool bar.
- Select the folder in which the project is to be saved from the **Save in** drop-down list.
- If you want to create a new folder for the project, click on the **Create new folder** button.
- Enter a name for the file in the **File name** field.
- Click **Save**.



As long as a project is not saved, an asterisk \* will be displayed next to the project name in the title bar of the SmartVisual software.

### 3.7 Displaying a project in the Viewer

Once the tables have been edited in the SmartVisual Editor, the project can be viewed in the SmartVisual Viewer. The current alarm status of the SmartCheck or ProLink devices is also displayed here.

- In the tool bar of the SmartVisual Editor, click on **Go to SmartVisual Viewer** .

The current project is displayed in the SmartVisual Viewer.

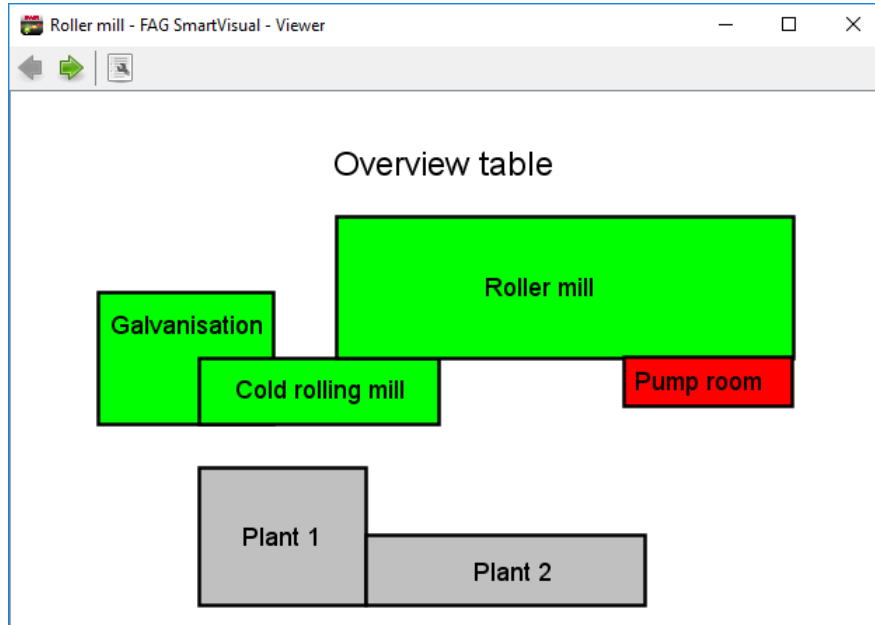

If an element links to the alarm status of a table containing several SmartCheck or ProLink devices, the overall alarm status will always be displayed; in other words the consolidated alarm status of all devices.

#### Switching between tables

If you have linked individual tables with one another, you can switch between them.

- Click on a linked element (e.g. "Pump room").

The table containing the photo of the pump room and the SmartCheck or ProLink devices, together with their alarm statuses, is displayed.

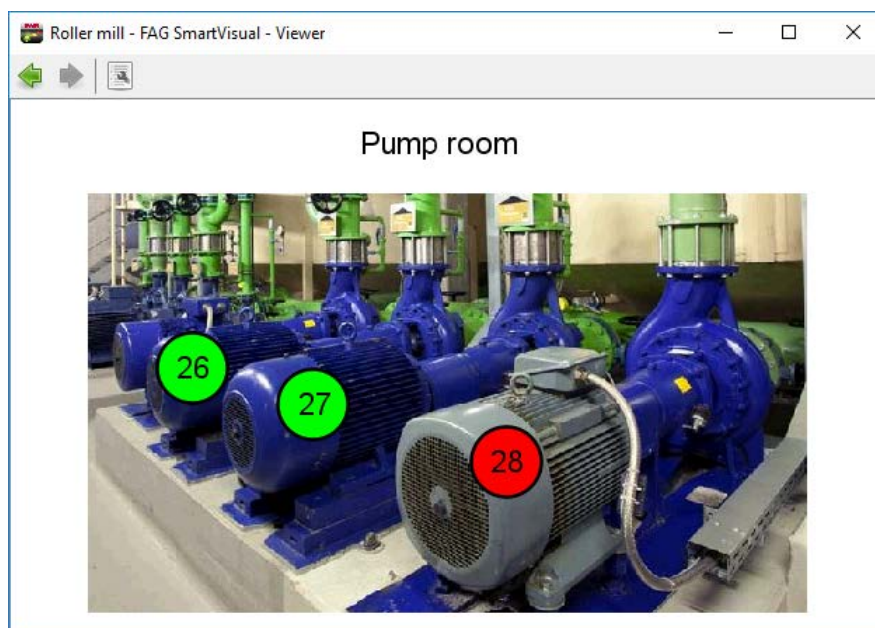

To switch between the individual tables, click on the arrows  and .

**Opening SmartCheck or ProLink devices**

Clicking on an element that is linked with a device will automatically open the SmartCheck or ProLink device in the browser.

- Click on a SmartCheck or ProLink element and
- select **Open web interface**.

The following screenshot shows a sample status page of a SmartCheck device in the SmartWeb software:

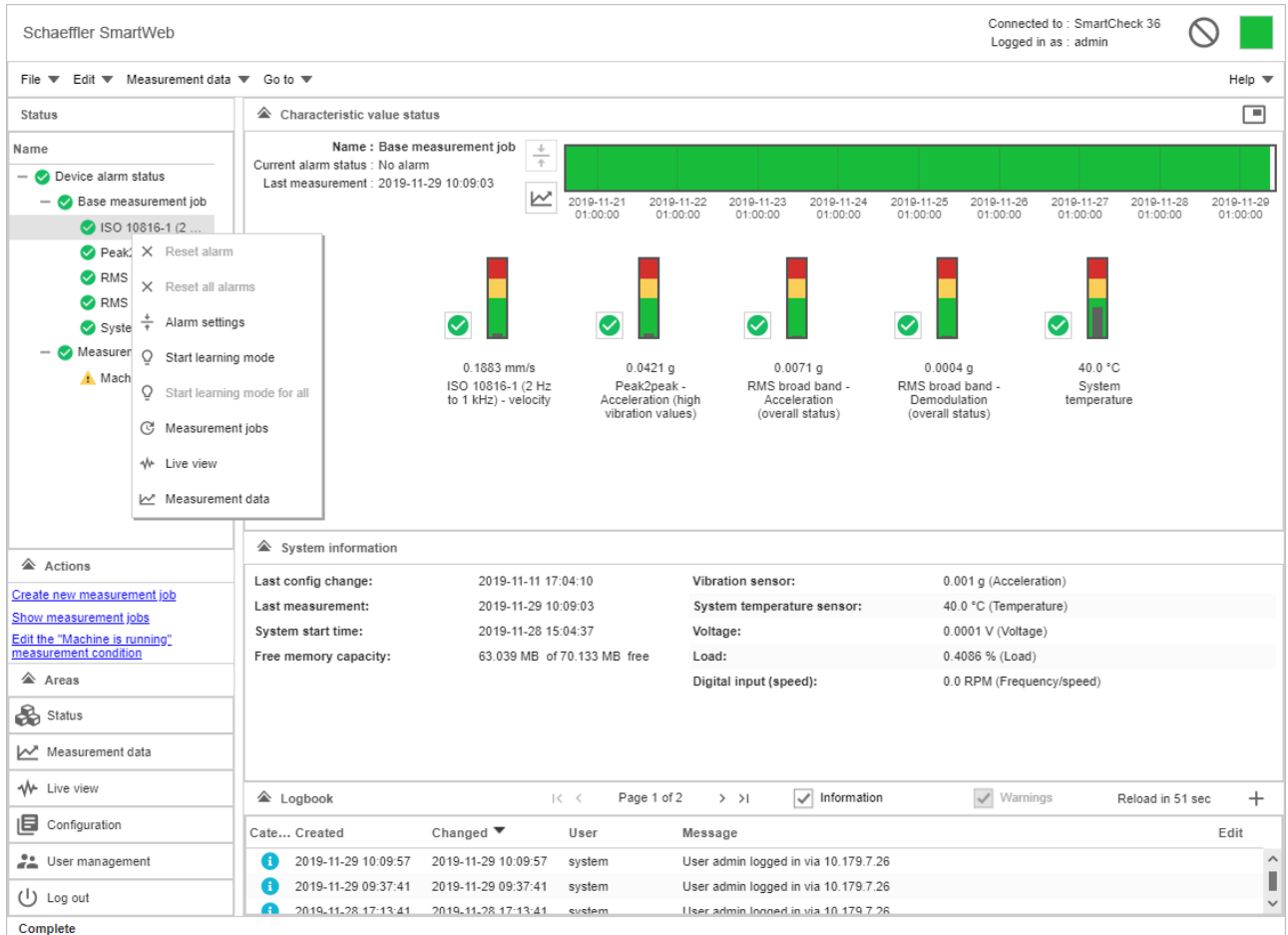

If you cannot access the SmartWeb software, please check whether all requirements for starting up the software have been met. For more information, please see the section entitled **First start-up** in the handbook for the SmartWeb software.

**Switching to the SmartVisual Editor**

- Click on **Go to SmartVisual Editor**  in the tool bar.

---

## 3.8 Settings

### 3.8.1 Changing the language

Here you can set the language in which the SmartVisual software interface is displayed.



Changes only apply to SmartVisual.

---

#### Changing the language

Here you can set the language in which the SmartVisual software interface is displayed.

- In the menu, click on **Settings > Language** and
- select a language.

The SmartVisual software must be restarted for the changes to the language settings to become effective.

#### Exporting the language file

- In the menu, click on **Settings > Language** and
- select **Export language file**.
- Enter the directory and file name under which the language file is to be saved.

The downloaded language file can be found in the specified directory.



The CSV file is structured as follows:

```
# autogenerated from smartvisu
# Tue Oct 15 07:39:12 CEST 2013
ID;Deutsch;English
about.btn.activate;Aktivieren;Activate
about.btn.close;Schließen;Close
```

---

#### Editing the language file

The SmartVisual language file can easily be edited in an editor program or in OpenOffice Calc to add an extra language, for example. If you are editing the language file in a spreadsheet program, please be aware that the first column, the text ID and the subsequent columns retain the individual translations.

1. Start OpenOffice Calc.
2. Open the language file in CSV format.
3. Configure the following settings in the text import wizard:
  - Character encoding: **UTF-8**
  - Delimiter: **;** (semi-colon)
  - Text separator: **none** (blank)
4. Click on **OK**.

The language file is displayed as a spreadsheet.

|    | A                                   | B  | C                                     | D                   |
|----|-------------------------------------|--|---------------------------------------|---------------------|
| 1  | # autogenerated from smartvisu      |  |                                       |                     |
| 2  | # Tue Apr 01 08:30:26 CEST 2014     |  |                                       |                     |
| 3  |                                     |  |                                       |                     |
| 4  | <b>ID</b>                           | <b>Deutsch</b>                           | <b>English</b>                        | <b>New language</b> |
| 5  | about.btn.activate                  | Aktivieren                               | Activate                              |                     |
| 6  | about.btn.close                     | Schließen                                | Close                                 |                     |
| 7  | about.email                         | E-Mail                                   | Email                                 |                     |
| 8  | about.firmname                      | FAG Industrial Services GmbH             | FAG Industrial Services GmbH          |                     |
| 9  | about.general                       | Allgemeine Anfragen                      | General Enquiries                     |                     |
| 10 | about.general.mail                  | industrial-services@schaeffler.com       | industrial-services@schaeffler.com    |                     |
| 11 | about.general.tel                   | +49 (0) 2407 9149-66                     | +49 (0) 2407 9149-66                  |                     |
| 12 | about.internet                      | Internet                                 | Internet                              |                     |
| 13 | about.internet.url                  | http://www.schaeffler.de/services        | http://www.schaeffler.com/services    |                     |
| 14 | about.tecsupport                    | Technische Unterstützung                 | Technical Support                     |                     |
| 15 | about.tecsupport.mail               | support.is@schaeffler.com                | support.is@schaeffler.com             |                     |
| 16 | about.tecsupport.tel                | +49 (0) 2407 9149-99                     | +49 (0) 2407 9149-99                  |                     |
| 17 | about.tel                           | Telefon                                  | Telephone                             |                     |
| 18 | about.title                         | Info                                     | Info                                  |                     |
| 19 | about.version                       | Version                                  | Version                               |                     |
| 20 | colorChooser.title                  | Farbauswahl                              | Colorizer                             |                     |
| 21 | optionsFrame.button.cancel          | Abbrechen                                | Cancel                                |                     |
| 22 | optionsFrame.button.ok              | OK                                       | OK                                    |                     |
| 23 | optionsFrame.error.portOutOfRange   | Die Ports müssen zwischen 1024 und 65535 | Ports must be between 1024 and 65535. |                     |
| 24 | optionsFrame.label.smartCheckConfig | Gerätekonfiguration                      | Device configuration                  |                     |
| 25 | optionsFrame.label.smartCheckSearch | Gerätesuche                              | Device search                         |                     |
| 26 | optionsFrame.label.udpPorts         | UDP-Ports für:                           | UDP ports for:                        |                     |
| 27 | optionsFrame.title                  | UDP-Ports einstellen                     | Set UDP ports                         |                     |



- Before editing the file, make sure that a back-up copy is saved.
- The language file contains placeholders such as %d and %s. These must not be changed.
- If you are editing the file in Microsoft Excel, it will not be possible to import the file again at a later point. Please use OpenOffice Calc.

5. Create a column for the language you wish to add (e.g. 'New language').

6. Translate the text.

7. Save the language file in CSV format with the settings from point 3.

Check that the CSV file has saved in the correct format before importing into the SmartVisual software.

### Importing a language file

Once you have edited the language file, you can import it back into the SmartVisual software.

- In the menu, click on **Settings > Language** and
- select **Import language file**.

The new language file is used once the SmartVisual software has been restarted.

### 3.8.2 Changing the status update interval

Here you can define the intervals at which the alarm status of the SmartCheck or ProLink devices in the SmartVisual Viewer is queried. The following options are available: 10 seconds, 1 minute, 5 minutes and 10 minutes.

### 3.8.3 Setting the UDP ports

Here you can set the UDP communication ports for the device search and device configuration. The port for the device search is set to 19002 and the port for the device configuration is set to 19003 by default.



The following basic prerequisites apply for connecting to the computer:

- The communication protocol TCP must be enabled on port 80 and the UDP communication protocol enabled on ports 19002 to 19003 used in existing firewalls in your network.
- If the SmartCheck or ProLink device has not been assigned an address via DHCP, it will have the IP address 192.168.1.100 by default. In this case, the IP address of your computer must be within the 192.168.1.x range.
- During the initial installation of the SmartVisual software, the settings for the UDP ports are specified automatically. These automatic settings are generally correct

If there are any problems, please contact your system administrator.

### 3.9 Further information

Under ? > **Info**, you will find information on support and the current program version:

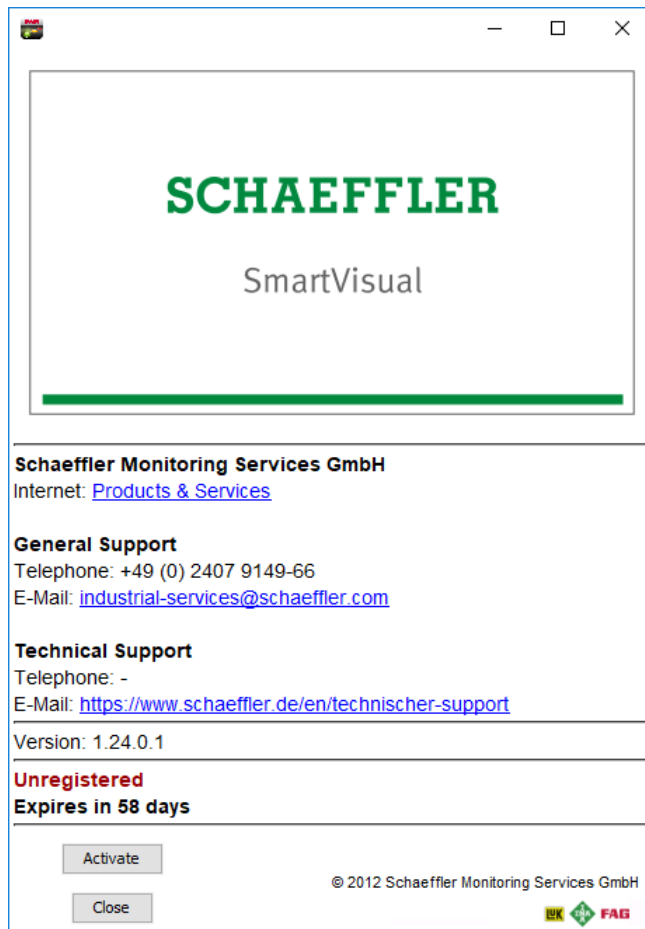

The following information is available:

- **Contact:** Here you will find detailed contact information, both for general enquiries and for support.
- **Version:** Here you will find details of the current program version. Please include your version number during any support requests.

Here you also have the following options:

- Click on **Activate** to register for the 60-day test version of the SmartVisual software.
- Click on **Close** to close the dialog box.

#### Information and services for our vibration monitoring systems

We offer a unique range of services for Schaeffler SmartCheck or ProLink – from training courses, technical mentoring during the induction phase and expert support with diagnostic issues, right through to customised service agreements including remote monitoring and reporting.

A look at the extensive range of products and services relating to Schaeffler SmartCheck or ProLink can be found online:

- SmartCheck: [www.schaeffler.de/en/condition-monitoring/smartcheck](http://www.schaeffler.de/en/condition-monitoring/smartcheck)
- ProLink: [www.schaeffler.de/en/condition-monitoring/prolink](http://www.schaeffler.de/en/condition-monitoring/prolink)

### 3.10 Registering the software

You can use the SmartVisual software for a period of 60 days free of charge. After the 60 days, the software is only partially usable. So you can no longer store projects and the alarm status of the SmartCheck or ProLink devices will no longer be updated.

If you buy the unlimited full version, you can continue using the software. Uninstalling the trial version is not necessary and all projects, that you have created during the test phase remain. You can unlock the SmartVisual software easily by a sent activation file. You only need the serial number (e.g. "12345678") that you will find on the supplied CD-Rom.

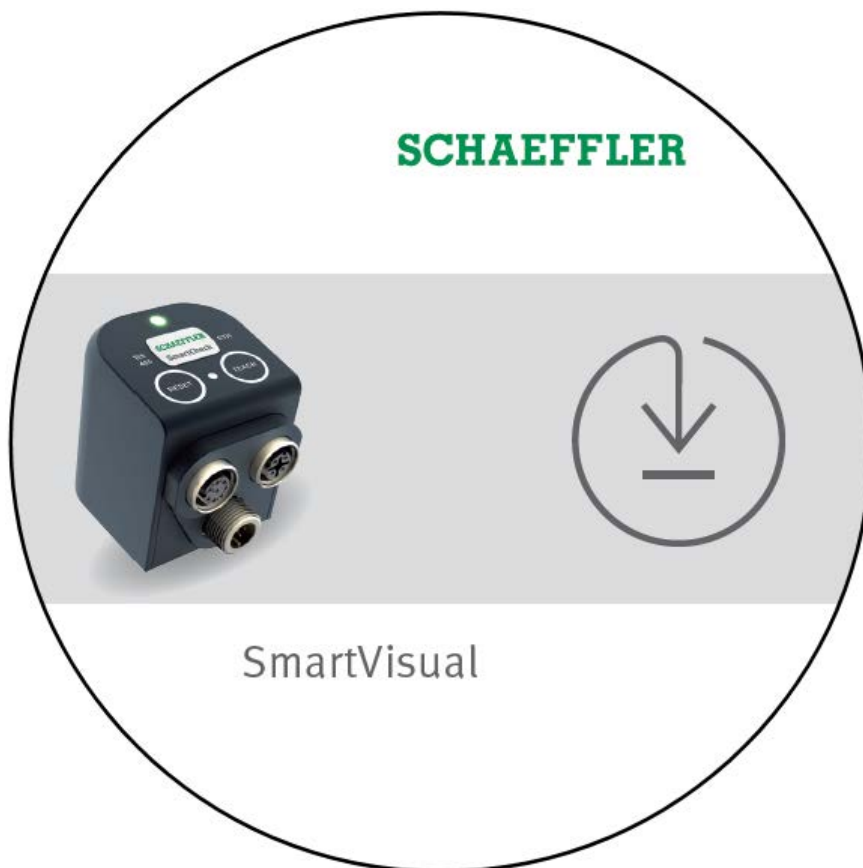

- Please have the serial number ready of your SmartVisual software CD-ROM.
  - Call our support or send an e-mail to [industrial-services@schaeffler.com](mailto:industrial-services@schaeffler.com).
- You will receive an activation file by e-mail. Please put the file in a save place.
- Save the activation file to the computer on which the SmartVisual software is installed.
  - Start the SmartVisual software.
  - Click on the menu bar on **? > Info**.
  - Select **Activate** and
  - choose the activation file.

Now you can use the SmartVisual software without restriction.

---

## 4 Manufacturer/support

### Manufacturer

#### Schaeffler Monitoring Services GmbH

Kaiserstraße 100  
52134 Herzogenrath  
Germany

Tel.: +49 2407 9149-66  
Fax: +49 2407 9149-59

Internet: [www.schaeffler.com/en/services](http://www.schaeffler.com/en/services)

Further information:

- [www.schaeffler.de/en/condition-monitoring/smartcheck](http://www.schaeffler.de/en/condition-monitoring/smartcheck)
- [www.schaeffler.de/en/condition-monitoring/prolink](http://www.schaeffler.de/en/condition-monitoring/prolink)

Contact: [industrial-services@schaeffler.com](mailto:industrial-services@schaeffler.com)

Please send all correspondence directly to Schaeffler Monitoring Services GmbH!

A subsidiary of

#### Schaeffler Technologies AG & Co. KG

PO Box 1260  
97419 Schweinfurt  
Germany

Georg-Schäfer-Straße 30  
97421 Schweinfurt  
Germany

### Support

For information on technical support, go to [www.schaeffler.de/en/technical-support](http://www.schaeffler.de/en/technical-support).

We provide support services for the device and related software products. For a detailed description of the nature and scope of our support services, go to:

- [www.schaeffler.de/en/condition-monitoring/smartcheck](http://www.schaeffler.de/en/condition-monitoring/smartcheck)
- [www.schaeffler.de/en/condition-monitoring/prolink](http://www.schaeffler.de/en/condition-monitoring/prolink)

You can find the support definition in the "Technical documents" > "Software, Licences, Manuals" section.