

SCHAEFFLER



Induction Heating Devices **HEATER**

User manual

Foreword

The induction heating devices HEATER25, HEATER50, HEATER100, HEATER200, HEATER400, HEATER800 and HEATER1600 give rapid, clean operation. Their high efficiency level allows energy-efficient heating and shorter mounting times. This reduces the operating costs. The uniform, controlled heating allows consistently good quality of mounting.

Operation is simple and user-friendly, the touch-sensitive screen is oil-resistant, dustproof and waterproof.

When heating by induction is used, there is no need at all to use oil – this gives particularly good environmental compatibility. The scope of application is very extensive. It is possible to heat the loose inner rings of cylindrical or needle roller bearings as well as sealed and greased bearings. Compared with previous models, further improvements have been made in performance capacity and safety and the part to be heated need no longer be of a minimum mass.

In order to ensure durability in demanding industrial operation, the devices are extremely robust and reliable.

Current version

An induction heating unit is controlled by means of an operator unit with a touch-sensitive screen. The operator software can be developed further and an update is possible free of charge. Changes to the software can lead to adjustments in the user manual. A current version of this user manual can be found at <http://medien.schaeffler.com> using the search term BA42.

Contents

	Page
About the user manual	
Symbols	4
Signs.....	4
Availability	5
Legal guidelines	5
Original user manual	5
General safety guidelines	
Usage for the intended purpose	6
Usage not for the intended purpose	6
Qualified personnel.....	6
Hazards.....	7
Safety devices	8
Protective equipment	9
Safety regulations	10
Scope of delivery	
.....	12
Accessories.....	18
Damage during transit	18
Defects.....	18
Description	
Overview	19
Temperature sensor.....	20
Function	21
Operation	22
Operating modes.....	23
Temperature hold mode.....	27
Transport and storage	
Transport.....	28
Storage	32
Commissioning	
Hazard area.....	33
Initial stages	34
Voltage supply	34
Configuration	36

	Page
Operation	
Selecting a heating device	48
Selecting a support ledge.....	48
Changing the slewing ledge	49
Changing the vertical ledge	50
Positioning the rolling bearing	51
Connecting the temperature sensor.....	55
Selecting the heating method	57
Setting values.....	58
Heating.....	59
Cancelling temperature hold	60
Removing the temperature sensor	61
Removing the rolling bearing.....	62
Saving the heating curve.....	66
Troubleshooting	
General errors.....	67
Slight error	67
Serious error.....	68
Repair.....	68
Maintenance	
Maintenance plan	69
Decommissioning	70
Disposal	
Regulations	70
Technical data and accessories	
HEATER25	71
HEATER50.....	72
HEATER100.....	73
HEATER200.....	74
HEATER400.....	75
HEATER800.....	76
HEATER1600.....	77
Original accessories.....	77
Appendix	
EU Declaration of Conformity.....	78

Induction heating devices HEATER

About the user manual

This user manual is part of the device and contains important information.

Symbols

The warning and hazard symbols are defined in accordance with ANSI Z535.6-2006.



In case of non-compliance, death or serious injury will occur. ◀



In case of non-compliance, death or serious injury may occur. ◀











In case of non-compliance, damage or malfunctions in the product or the adjacent construction will occur. ◀

Signs

The warning, prohibition and instruction signs are defined in accordance with DIN 4884-2 and DIN EN ISO 7010.

Warning, prohibition and instruction signs

Signs and descriptions	
	Warning of magnetic field
	Warning of non-ionising, electromagnetic radiation
	Warning of hot surface
	Prohibited for persons with heart pacemaker
	Prohibited for persons with metallic implants
	Carrying of metallic parts or watches prohibited
	Observe manual
	Wear safety gloves
	Wear safety shoes

Availability

This user manual is supplied with each device and can also be ordered retrospectively.



If the user manual is missing, incomplete or illegible, the user may make errors.

The Safety Officer must ensure that this user manual is always complete and legible and that any persons using the device have the user manual available. <

Legal guidelines

The information in this manual corresponded to the most recent status at the close of editing. The illustrations and descriptions cannot be used as grounds for any claims relating to devices that have already been delivered. Schaeffler Technologies AG & Co. KG accepts no liability for any damage or malfunctions if the device or accessories have been modified or used in an incorrect manner.

Original user manual

The original user manual is taken to be a user manual in the German language. A user manual in another language is to be taken as a translation of the original user manual.

Induction heating devices HEATER

General safety guidelines

A description is given of how the device may be used, who may use the device and what must be observed when using the device.

Usage for the intended purpose

Usage for the intended purpose of the induction heating device is defined as the industrial heating of rolling bearings and other rotationally symmetrical, ferromagnetic workpieces. Sealed and greased rolling bearings can also be heated. In this case, the maximum permissible heating temperatures for the seal and grease must be observed.

Usage not for the intended purpose

The heating device may not be used for the heating of parts that are not ferromagnetic or not rotationally symmetrical. Do not use the heating device in an environment with a risk of explosion.

Usage not for the intended purpose can lead to the injury or death of persons or damage to the device.

Qualified personnel

For safety reasons, the heating device may only be operated by qualified personnel.

A person defined as qualified personnel:

- has all the necessary knowledge
- is aware of all the hazards and safety guidelines
- is authorised to use the heating device by the safety co-ordinator
- has fully read and understood this user manual.

Work on electrical devices

The heating device HEATER1600 may only be connected by a trained electrician. The switch cabinet may only be opened by an electrician. Only an electrician is in a position, on the basis of his technical training, knowledge and experience as well as his knowledge of the appropriate regulations, to carry out work on electrical devices correctly and recognise possible hazards.

Hazards During operation, the device always generates an electromagnetic field. The electromagnetic field heats ferromagnetic parts and can disrupt or destroy electronic components. Examples include watches, clocks, mobile telephones, credit cards and other data carriers as well as electronic circuits.



Danger of heart stoppage in persons fitted with a pacemaker due to the strong electromagnetic field.

Persons fitted with a pacemaker must remain outside the hazard area of the heating device, see page 33. ◀



Danger of death for persons with artificial heart valves made from metal, hazard of severe burns due to heating of implants by the electromagnetic field.

Persons with ferromagnetic implants must remain outside the hazard area of the heating device, see page 33. ◀

Implants Persons with implants must clarify with a doctor whether the implants are ferromagnetic before working with an induction heating device.

The following list is not exhaustive but is intended to give the user an initial overview of the types of implants that may be hazardous:

- artificial heart valve
- ICD
- stent
- hip implant
- knee implant
- metal plate
- metal screw
- dental implant and dentures
- cochlear implant
- neurostimulator
- insulin pump
- hand prosthesis
- subcutaneous piercing.

Induction heating devices HEATER

Metallic objects Persons with a metallic object must clarify whether it is ferromagnetic before working with an induction heating device. The following list is not exhaustive but is intended to give the user an initial overview of the types of metallic objects that may be hazardous:

- prosthetic
- spectacles
- hearing aid
- earring
- piercing
- brace
- chain
- ring
- armband
- keys
- timepiece
- coin
- ballpoint pen, fountain pen
- belt
- shoes with metal caps or metal springs in the sole.

Safety devices In order to protect the user and the heating device, the following safety devices are present:

- The temperatures of the cooling element, coil and housing are continuously monitored. The thermal protection system will switch off the heating device before any component is overheated. Once the thermal protection system has been triggered, the heating device can be put back into operation once the error has been eliminated and the device has been checked.
- The heating of the rolling bearing is continuously monitored. If the specified increase in temperature is not achieved within a certain period, the heating device is switched off by the software.

Operation

In order that the user can move out of the hazard area before the electromagnetic field is generated, the following operating options are available:

- The operator can set the time on the heating device that is counted down after pressing the START/STOP key before the electromagnetic field is generated. The user can then move out of the hazard area within the countdown time.



Risk of damage to health from remaining in a strong electromagnetic field, since the device starts the heating operation unexpectedly.

Set a sufficiently long countdown time in order to allow exit from the hazard area. <

Activity display

During the heating operation, an animation with a red rectangle is visible. The user can thus recognise during heating when the electromagnetic field is being generated. During demagnetisation, the electromagnetic field is indicated by a red circle with a white exclamation mark.

Protective equipment

Personal protective equipment is intended to protect operating personnel against health hazards. This comprises safety shoes and gloves that are heat-resistant up to +250 °C and these must be used in the interests of personal safety.

Induction heating devices HEATER

- Safety regulations** The following safety regulations must be observed when working with the heating device. Further guidance on hazards and specific guidelines for action can be found, for example, in the section *Operation*, page 48.
- Transport** The heating device must not be moved directly after heating.
- Storage** The heating device must always be stored under the following ambient conditions:
- humidity max. 90%, non-condensing
 - protected against sunlight and UV radiation
 - no explosion risk in the environment
 - no aggressive chemicals in the environment
 - temperature from -40 °C to $+40\text{ °C}$.
- If the heating device is stored under unsuitable ambient conditions, this will probably have consequences such as damage to the electronic unit, corrosion of the ground contact surfaces and deformation of the plastic housing.
- Commissioning** The heating device must not be modified.
- The heating device may only be commissioned if it fulfils the regulations to be adhered to at the place of use.
- Only original accessories and replacement parts may be used.
- The heating device may only be used in well ventilated rooms.
- Do not feed the mains connection cable through the U-shaped core.

Operation The heating device may only be operated under the following ambient conditions:

- closed room
- subsurface flat and capable of supporting loads
- humidity min. 5%, max. 90%, non-condensing
- no explosion risk in the environment
- no aggressive chemicals in the environment
- temperature from 0 °C to +40 °C.

If the heating device is operated under unsuitable ambient conditions, this can have consequences such as damage to the electronic unit, corrosion of the ground contact surfaces and deformation of the plastic housing.

The heating device may only be operated at the correct supply voltage.

Workpieces must not be heated if they are covered.

Workpieces must not be heated if they exceed the maximum permissible mass, see *table*, page 48.

Workpieces must not be suspended from ropes or chains made from ferromagnetic material while they are heated.

During the heating process, the user must maintain a distance of at least 2 m from the heating device.

Objects made from ferromagnetic material must be kept at a distance of at least 1 m from the heating device.

Support, slewing and vertical ledges must not be produced independently.

The heating device may only be switched on if the support, slewing or vertical ledge is correctly positioned.

The support, slewing or vertical ledge must never be removed during the heating process.

The heating device must not be switched off by means of the main switch while the device is heating a component.

Any smoke or vapour occurring during the heating process must not be inhaled.

The heating device must be switched off using the main switch if it is not in use.



Back injuries due to incorrect handling of heavy rolling bearings. In the case of heavy rolling bearings, use suitable lifting gear. <

Induction heating devices HEATER

Maintenance The heating device must be switched off before maintenance is carried out.

Disposal Locally applicable regulations must be observed.

Conversion The heating device must not be converted.

Scope of delivery The scope of supply comprises the heating device, standard accessories, safety guidelines, user manuals, and a USB stick.

Scope of delivery Heating device HEATER25

Component	Designation	d ¹⁾ mm
Heating device	HEATER25	–
Support ledge	HEATER50.LEDGE-55²⁾	55
Grease	ARCANOL-MULTI3-250G	–
Temperature sensor	HEATER.SENSOR-500MM	–
Lifting tool	HEATER50.CARRY²⁾	–
Gloves	–	–
Safety guidelines	–	–
German user manual	–	–
English user manual	–	–
USB stick	–	–

1) Minimum inside diameter of rolling bearing.

2) Designation deviates from the naming system as the component is also used for HEATER50.

- ① Heating device
- ② Support ledge 55
- ③ Grease
- ④ Temperature sensor, magnetic
- ⑤ Lifting tool
- ⑥ Gloves
- ⑦ Safety guidelines
- ⑧ User manuals (German and English)
- ⑨ USB stick

Figure 1
Scope of delivery
Heating device HEATER25



**Scope of delivery
Heating device HEATER50**

Component	Designation	d ¹⁾ mm
Heating device	HEATER50	–
Support ledge	HEATER50.LEDGE-55	55
Grease	ARCANOL-MULTI3-250G	–
Temperature sensor	HEATER.SENSOR-500MM	–
Lifting tool	HEATER50.CARRY	–
Gloves	–	–
Safety guidelines	–	–
German user manual	–	–
English user manual	–	–
USB stick	–	–

1) Minimum inside diameter of rolling bearing.

- ① Heating device
- ② Support ledge 55
- ③ Grease
- ④ Temperature sensor, magnetic
- ⑤ Lifting tool
- ⑥ Gloves
- ⑦ Safety guidelines
- ⑧ User manuals (German and English)
- ⑨ USB stick

Figure 2
Scope of delivery
Heating device HEATER50



Induction heating devices HEATER

Scope of delivery Heating device HEATER100

Component	Designation	d ¹⁾ mm
Heating device	HEATER100	–
Slewing ledge	HEATER100.LEDGE-70	70
Grease	ARCANOL-MULTI3-250G	–
Temperature sensor	HEATER.SENSOR-500MM	–
Lifting tool	HEATER100.CARRY	–
Gloves	–	–
Safety guidelines	–	–
German user manual	–	–
English user manual	–	–
USB stick	–	–

1) Minimum inside diameter of rolling bearing.

- ① Heating device
- ② Slewing ledge 70
- ③ Grease
- ④ Temperature sensor, magnetic
- ⑤ Lifting tool
- ⑥ Gloves
- ⑦ Safety guidelines
- ⑧ User manuals (German and English)
- ⑨ USB stick

Figure 3
Scope of delivery
Heating device HEATER100



**Scope of delivery
Heating device HEATER200**

Component	Designation	d ¹⁾ mm
Heating device	HEATER200	–
Slewing ledge	HEATER200.LEDGE-100	100
Grease	ARCANOL-MULTI3-250G	–
2×temperature sensor	HEATER.SENSOR-1000MM	–
Lifting tool	HEATER200.CARRY	–
Gloves	–	–
Safety guidelines	–	–
German user manual	–	–
English user manual	–	–
USB stick	–	–

1) Minimum inside diameter of rolling bearing.

- ① Heating device
- ② Slewing ledge 100
- ③ Grease
- ④ Temperature sensor, magnetic
- ⑤ Lifting tool
- ⑥ Gloves
- ⑦ Safety guidelines
- ⑧ User manuals (German and English)
- ⑨ USB stick

Figure 4
Scope of delivery
Heating device HEATER200



Induction heating devices HEATER

Scope of delivery Heating device HEATER400

Component	Designation	d ¹⁾ mm
Heating device	HEATER400	–
Vertical ledge	HEATER400.LEDGE-120	120
Grease	ARCANOL-MULTI3-250G	–
2×temperature sensor	HEATER.SENSOR-1000MM	–
Gloves	–	–
Safety guidelines	–	–
German user manual	–	–
English user manual	–	–
USB stick	–	–

1) Minimum inside diameter of rolling bearing.

- ① Heating device
- ② Vertical ledge 120
- ③ Grease
- ④ Temperature sensor, magnetic
- ⑤ Gloves
- ⑥ Safety guidelines
- ⑦ User manuals (German and English)
- ⑧ USB stick

Figure 5
Scope of delivery
Heating device HEATER400

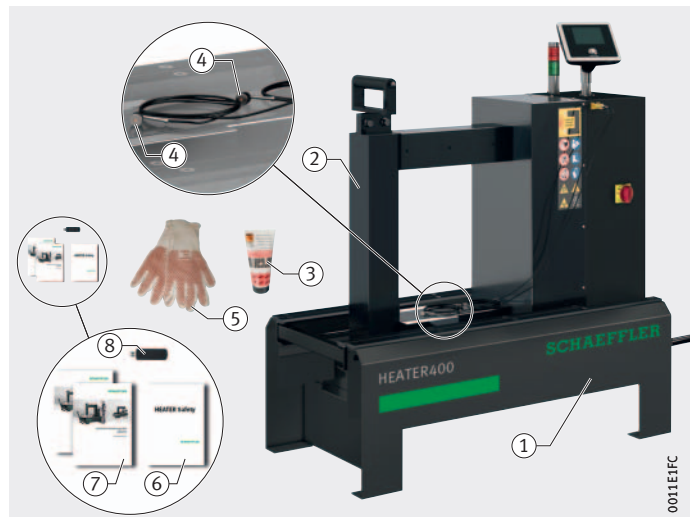

Scope of delivery
Heating device HEATER800

Component	Designation	d ¹⁾ mm
Heating device	HEATER800	–
Vertical ledge	HEATER800.LEDGE-150	150
Grease	ARCANOL-MULTI3-250G	–
2×temperature sensor	HEATER.SENSOR-1500MM	–
Gloves	–	–
Safety guidelines	–	–
German user manual	–	–
English user manual	–	–
USB stick	–	–

1) Minimum inside diameter of rolling bearing.

- ① Heating device
- ② Vertical ledge 150
- ③ Grease
- ④ Temperature sensor, magnetic
- ⑤ Gloves
- ⑥ Safety guidelines
- ⑦ User manuals (German and English)
- ⑧ USB stick

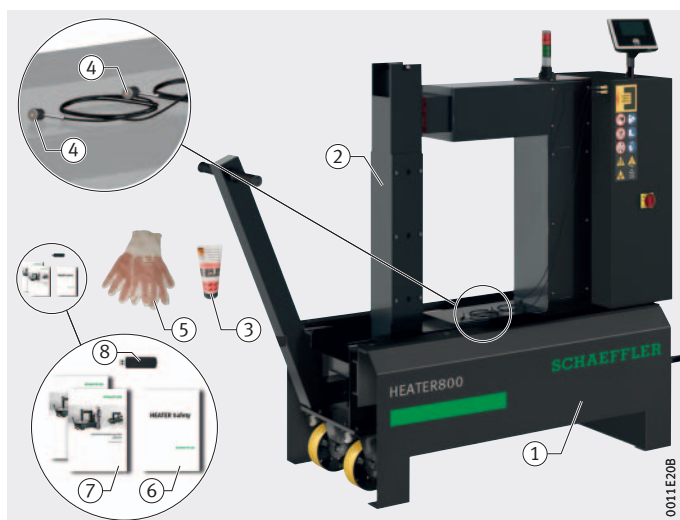

Figure 6
Scope of delivery
Heating device HEATER800

Induction heating devices HEATER

Scope of delivery Heating device HEATER1600

Component	Designation	d ¹⁾ mm
Heating device	HEATER1600	–
Vertical ledge	HEATER1600.LEDGE-220	220
Grease	ARCANOL-MULTI3-250G	–
2×temperature sensor	HEATER.SENSOR-1500MM	–
Gloves	–	–
Safety guidelines	–	–
German user manual	–	–
English user manual	–	–
USB stick	–	–

¹⁾ Minimum inside diameter of rolling bearing.

- ① Heating device
- ② Vertical ledge 220
- ③ Grease
- ④ Temperature sensor, magnetic
- ⑤ Gloves
- ⑥ Safety guidelines
- ⑦ User manuals (German and English)
- ⑧ USB stick

Figure 7
Scope of delivery
Heating device HEATER1600

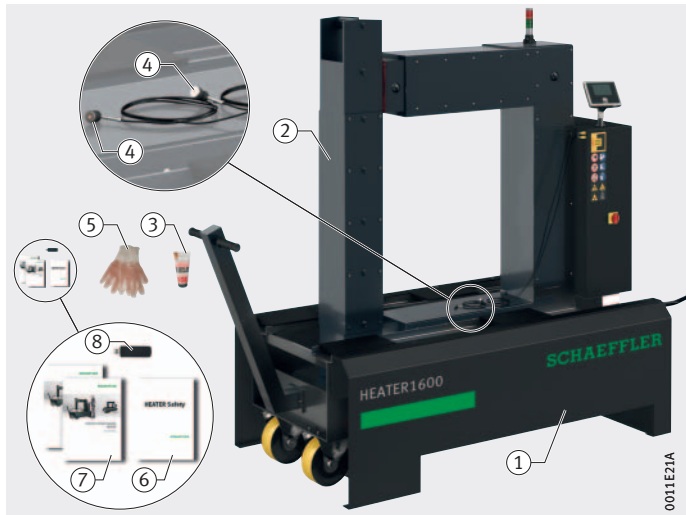

Accessories

The heating device is supplied with standard accessories. Special accessories such as support, slewing or vertical ledges in other sizes are available, see page 71.

Damage during transit

Any damage during transit must be reported as a complaint to the carrier.

Defects

Any defects must be reported promptly to Schaeffler Technologies AG & Co. KG.

Description

The heating device is robust and is operated by means of a touch-sensitive screen and a mechanical key below the touch-sensitive screen.

Overview

The components are made from the most suitable materials for the particular function, *Figure 8*.

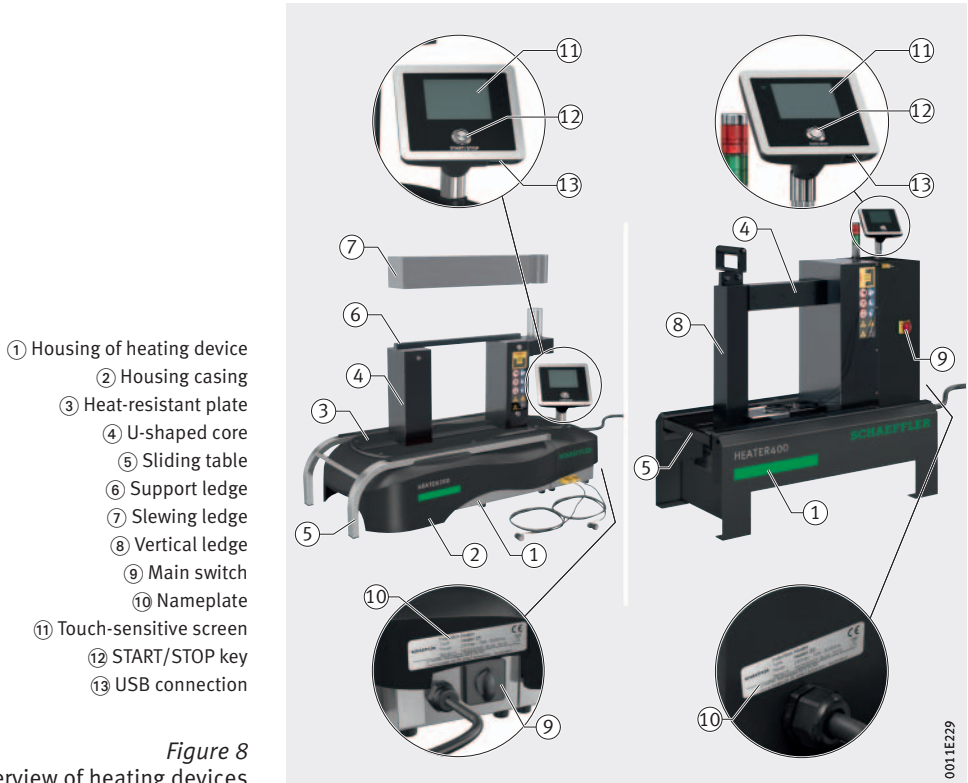

Figure 8
Overview of heating devices

Housing

The tabletop devices have a housing made from high grade steel, while the standalone devices have a housing made from painted sheet steel. The housing encloses the electronic unit, parts of the U-shaped core and the primary coil.

Housing casing

The housing of the tabletop devices has a casing made from PUR.

Heat-resistant plate

The heat-resistant plate between the struts of the U-shaped core comprises a fabric reinforced by carbon fibres.

U-shaped core

This is made from steel and protrudes partially from the housing. In the housing, the primary coil is axially arranged symmetrically around the U-shaped core, *Figure 10*, page 21.

Induction heating devices HEATER

Sliding table	The tabletop devices have a sliding table made from high grade steel, while the standalone devices have a sliding table made from painted sheet steel. In the case of HEATER800 and HEATER1600, the sliding table has wheels and a grip for screw mounting. It has support strips made from silicone.
Support ledge	This is made from the same material as the U-shaped core. The support ledge is not guided and is laid on the two upper ends of the U-shaped core.
Slewing ledge	This is made from the same material as the U-shaped core. The slewing ledge is fitted on the locating stud and is slewed on the U-shaped core.
Vertical ledge	This is made from the same material as the U-shaped core. The vertical ledge is guided at the top end of the U-shaped core and can be lifted and changed.
Main switch	This is used to switch the heating device on and off.
Touch-sensitive screen	The heating device is adjusted, started and stopped by means of the touch-sensitive screen mounted on the housing.
USB connection	A USB stick can be connected to the USB connector. This can be used to update firmware and import menu languages.
Temperature sensor	Two temperature sensors can be connected to each induction heating device. The sensor head of the temperature sensor is magnetic and is positioned on the component. The signal is fed via the cable and plug to the device, <i>Figure 9</i> .

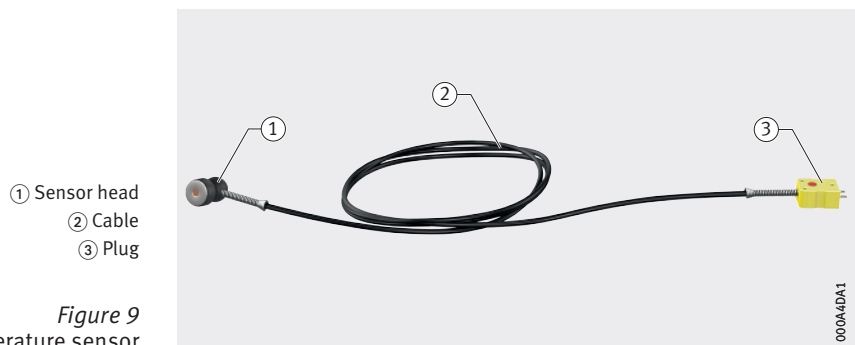

Figure 9
Temperature sensor

Function

An induction heating device generates a strong electromagnetic field and can thus be used to heat a ferromagnetic workpiece. Due to heating, the workpiece expands, which makes mounting easier. A typical application is the heating of a rolling bearing. This manual therefore considers the heating of a rolling bearing.



Strong electromagnetic field. Cardiac arrest due to failure of the pacemaker.

Persons fitted with a pacemaker must remain outside the hazard area, see page 33. ◀

Functional principle

The primary coil generates an electromagnetic alternating field. This electromagnetic field is transmitted via the iron core to the secondary coil, for example a rolling bearing, *Figure 10*. In the secondary coil, a high induction current at low voltage is induced. The induction current causes rapid heating of the rolling bearing. Any parts that are not ferromagnetic, as well as the heating device itself, remain cold.

During heating, an electromagnetic field is generated. After the heating operation is stopped, the field remains in place while the workpiece is being demagnetised (max. 5 s).

The electromagnetic field is very strong directly at the heating device. The electromagnetic field becomes weaker with increasing distance from the heating device.

- ① Primary coil
- ② Secondary coil, in this case a rolling bearing
- ③ U-shaped iron core
- ④ Ledge
- ⑤ Electromagnetic field

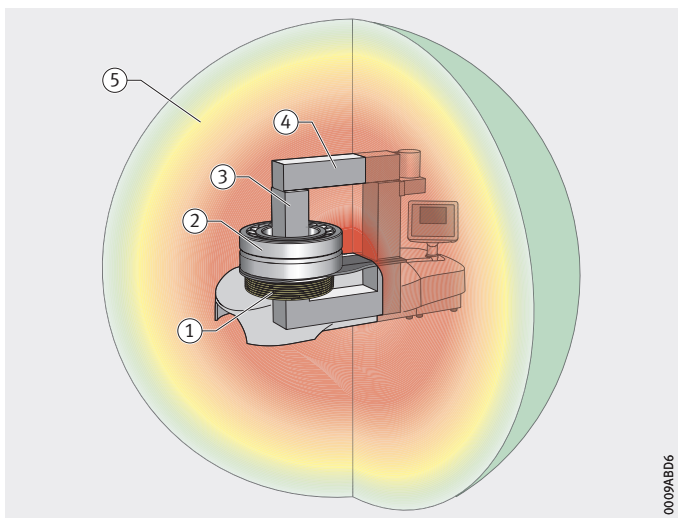

Figure 10
Function

0009ABD6

Induction heating devices HEATER

Operation The heating device is operated by means of a touch-sensitive screen, on which each heating method is indicated by a corresponding symbol. The symbol for the heating method currently in use is shown with a green border and the value or values currently set are displayed below the symbol, *Figure 11*.

- ① Time control
- ② Temperature control
- ③ Ramp control
- ④ Delta-T control
- ⑤ Set value

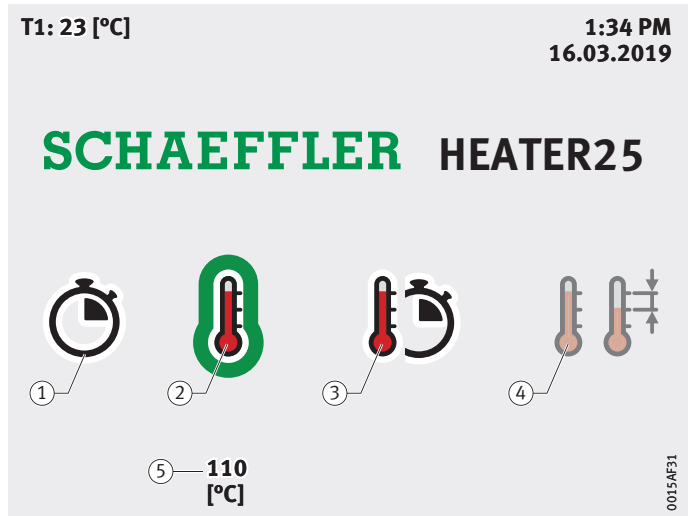

Figure 11
Heating methods, symbols

Heating is started using the mechanical key [START/STOP] below the touch-sensitive screen.

After pressing [START/STOP], the countdown time is counted down, *Figure 12*.

- ① [START/STOP]
- ② Display of countdown time



Figure 12
Countdown time

Once the countdown time has finished, the electromagnetic field is generated and the rolling bearing is heated.

Operating modes

The user sets which of the four operating modes the heating device should use.

Time control

In the case of time control, the heating time is set, *Figure 13*.

In order to determine the heating time for a rolling bearing, temperature control is used to heat the rolling bearing to the required temperature. The time required is noted as the heating time.

The advantage of time control compared to temperature control is that the temperature sensor is not necessary. Time control is therefore particularly suitable for the batch mounting of identical rolling bearings. When determining the heating time, it must be ensured that the initial temperature present is also maintained in the case of batch mounting.

Each time the heating temperature is reached, the heating device automatically starts the demagnetisation of the rolling bearing. After demagnetisation, "Heating operation ended" is displayed on the touch-sensitive screen, *Figure 46*, page 60.

- ① Initial temperature
- ② Heating temperature
- ③ Temperature of inner ring
- ④ Temperature of outer ring
- ⑤ Heating time

Figure 13
Time control

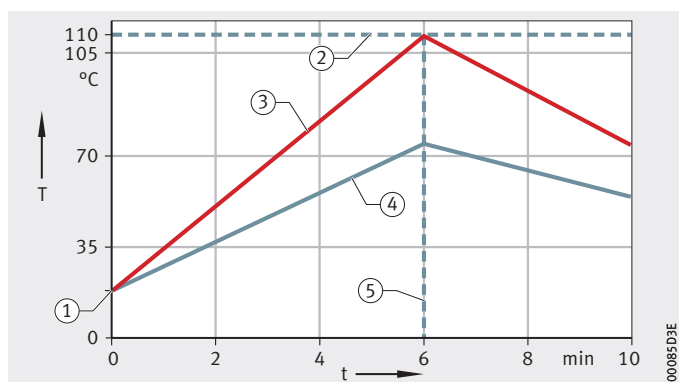

Standard bearings can be heated up to +120 °C, while rolling bearings with reduced clearance may be damaged even at lower temperatures.

NOTICE

Destruction of the bearing by heating to an excessively high temperature, since an excessively long period was inputted.

Always input the time determined in the test. ◀

NOTICE

Destruction of the heating device by heating to a temperature above +240 °C due to input of an excessively long period.

Check the current temperature continuously using a temperature gauge. ◀

Induction heating devices HEATER

Temperature control

In the case of temperature control, the heating temperature is set, *Figure 14*.

The device heats the rolling bearing as quickly as possible. When the heating temperature is reached, the rolling bearing is demagnetised and the message “Heating operation ended” is displayed, *Figure 46*, page 60. If temperature hold has been set and the rolling bearing falls below a specified temperature, it is heated again, see page 27.

- ① Initial temperature
- ② Heating temperature
- ③ Temperature of inner ring
- ④ Temperature of outer ring
- ⑤ Heating time

Figure 14
Temperature control

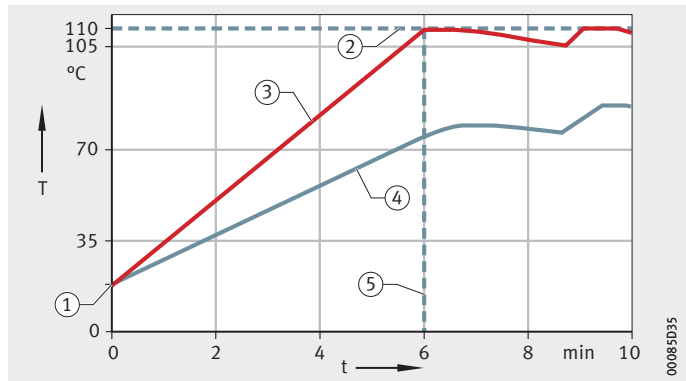

Heating time

The heating time is the time taken until the heating temperature is reached for the first time. The heating time depends on the size of the rolling bearing and the cross-section of the support, slewing or vertical ledge.

Ramp control

In the case of ramp control, the heating temperature and heating time are set, *Figure 15*.

Ramp control is primarily suitable for rolling bearings with reduced internal clearance and very thick-walled workpieces.

The advantage compared to temperature control is that the rolling bearing can be heated more slowly. The controller checks the temperature continuously and regulates the power level. The temperature differential between the inner ring and outer ring remains small, preventing stress and damage to the raceway due to the indentation of the rolling elements.

When the heating temperature is reached, the rolling bearing is demagnetised and the message "Heating operation ended" is displayed, *Figure 46*, page 60. If temperature hold has been set and the rolling bearing falls below a specified temperature, it is heated again, see page 27.

- ① Initial temperature
- ② Heating temperature
- ③ Temperature of inner ring
- ④ Temperature of outer ring
- ⑤ Heating time

Figure 15
Ramp control

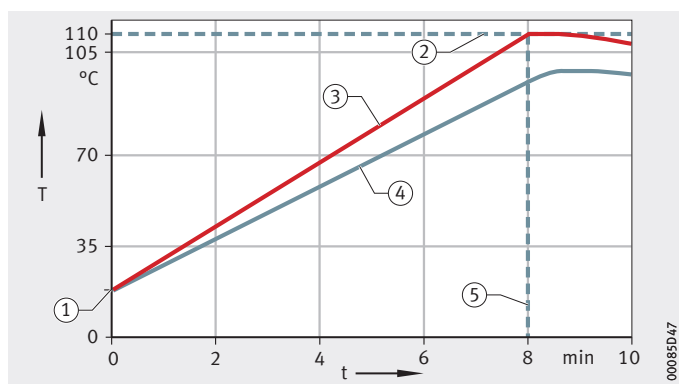

Induction heating devices HEATER

Delta-T control In the case of delta-T control, the heating temperature and maximum temperature differential are set, *Figure 16*.

Delta-T control is mainly suitable, similar to ramp control, for rolling bearings with reduced internal clearance.

The difference from ramp control is that not only the inner ring temperature is measured. In addition, the outer ring temperature is measured. The user inputs the maximum permissible temperature differential. The heating device continually checks the temperature differential during heating and reduces the power if the differential approaches the limit value and reduces the power very rapidly. If the limit value is reached, the device regulates the power to 0%, even if the heating temperature has not yet been reached. If the value undershoots the limit value by a sufficient amount, the heating device will regulate the power upwards again and the heating operation will be continued.

When the heating temperature is reached, the rolling bearing is demagnetised and the message "Heating operation ended" is displayed, *Figure 46*, page 60. If temperature hold has been set and the rolling bearing falls below a specified temperature, it is heated again, see page 27.

- ① Initial temperature
- ② Heating temperature
- ③ Temperature of inner ring
- ④ Temperature of outer ring
- ⑤ Heating time
- ⑥ Calculation period
- ⑦ Maximum temperature differential

Figure 16
Delta-T control

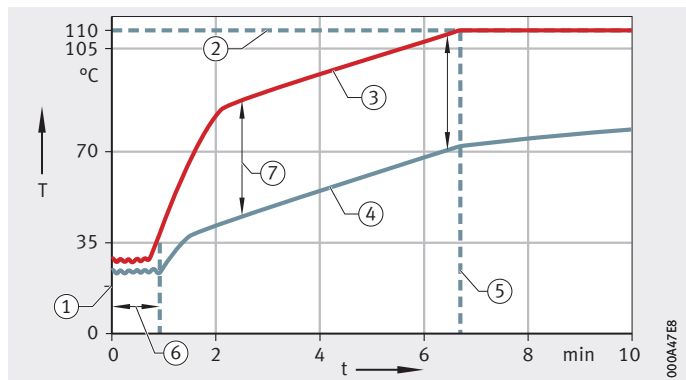

000A47EB

Temperature hold mode

This function of the heating device is only active in the operating modes:

- temperature control
- ramp control
- delta-T control.

Once the heating temperature is achieved, the heating device demagnetises the rolling bearing. If the temperature of the rolling bearing falls below the limit temperature, the heating device will again heat the rolling bearing to the heating temperature, *Figure 17*.

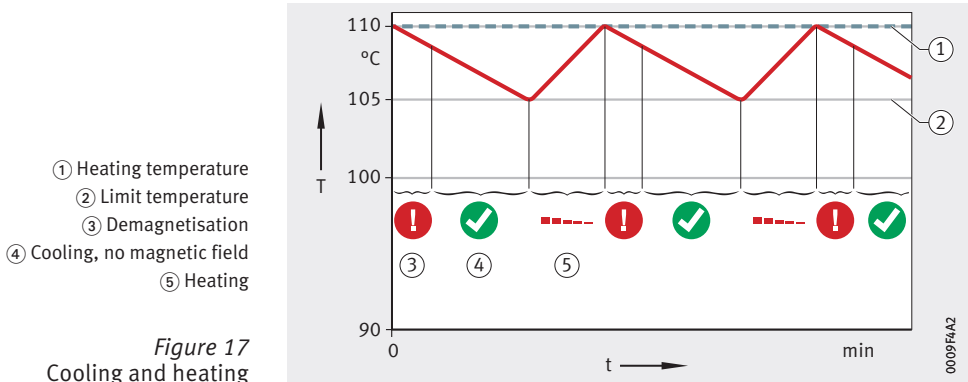

The user can maintain temperature hold by pressing [START/STOP]. If temperature hold is not maintained, temperature hold will stop once the temperature hold time has ended and the rolling bearing will cool again, *Figure 18*.

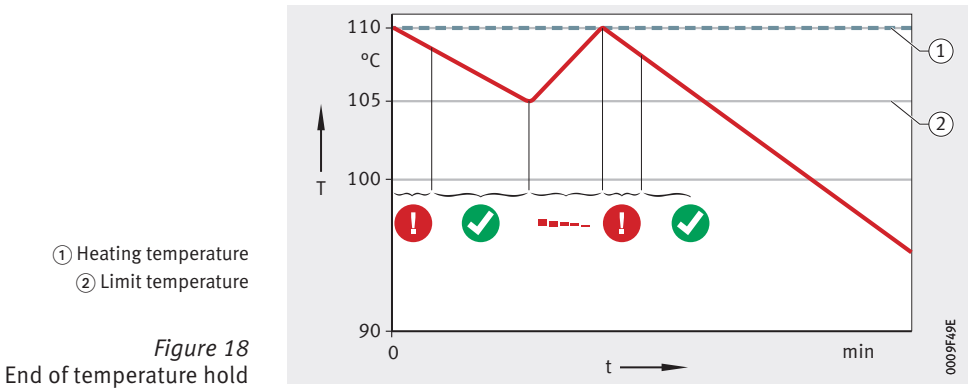

Induction heating devices HEATER

Transport and storage

The two smallest heating devices can be carried, while the larger and thus heavier heating devices are transported by means of a crane or pallet truck/fork lift truck. In order to protect a heating device against damage during storage, there are rules relating to permissible ambient conditions, see section *Storage*, page 10.

Transport

The safety regulations for transport must be observed, see page 10. For the transport of heavy heating devices, a device with sufficient load capacity must be used.

Transport of HEATER25 and HEATER50

This device can be carried with one hand using a lifting tool, *Figure 19*.



Hazard of leg or foot damage due to falling heating device if this becomes detached from the lifting tool.

Secure lifting tool by means of a cotter pin during transport. ◀



Hazard of falling injuries as a result of tripping due to hanging down of the mains connection cable.

Secure mains connection cable against dropping during transport. ◀

- ① Lifting tool
- ② Cotter pin
- ③ Mains connection cable

Figure 19
Transport of HEATER25 and HEATER50

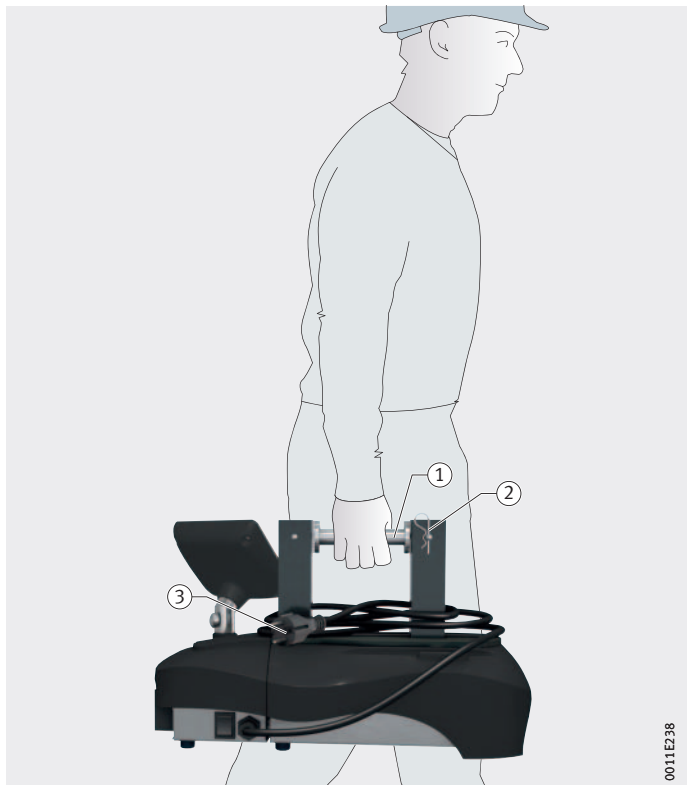

0011E238

Transport of HEATER100

This device can be carried using both hands. The protrusion on one side can be used as a hand grip. On the other side, a lifting tool can be screwed into the U-shaped core, *Figure 20*.



Hazard of falling injuries as a result of tripping due to hanging down of mains connection cable.

Secure mains connection cable against dropping during transport. <

- ① Lifting tool
- ② Mains connection cable

Figure 20
Transport of HEATER100

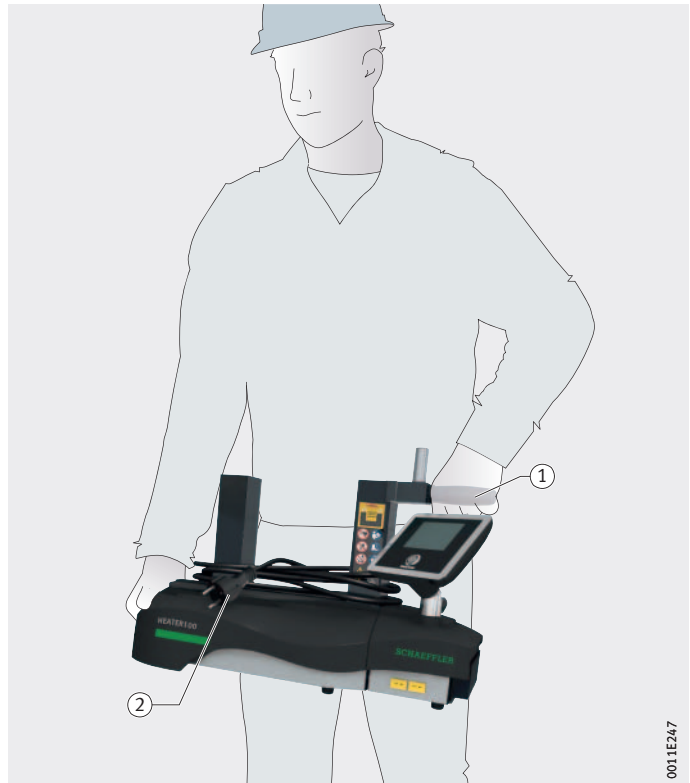

Induction heating devices HEATER

Transport of HEATER200

This device can be transported using a crane. A two-piece lifting tool can be fixed to the U-shaped core, *Figure 21*.



WARNING

Injuries due to falling heating device if this becomes detached from the lifting tool.

Secure transport handle by means of retaining nut during transport. ◀



WARNING

Destruction of mains connection cable and dropping of heating device by hooking of mains connection cable hanging down.

Secure mains connection cable against dropping during transport. ◀

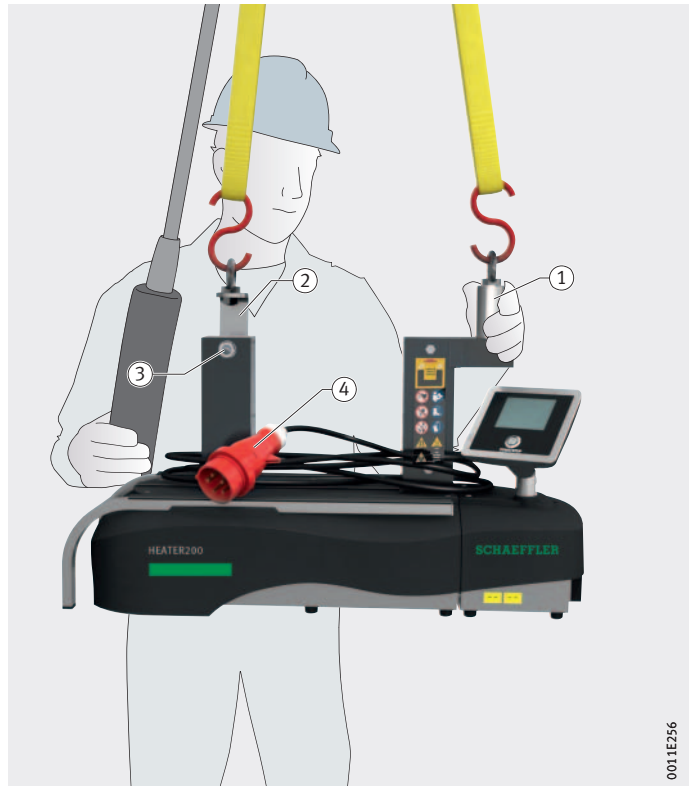

- ① Lifting tool, transport eyelet
- ② Lifting tool, transport handle
- ③ Retaining nut
- ④ Mains connection cable

Figure 21
Transport of HEATER200

0011E256

Transport of HEATER400 and HEATER800

These devices can be transported using a pallet truck or by means of a fork lift truck, *Figure 22*. The fork spacing is dependent on the device size, see *table*.

Fork spacing

Component	Designation	Fork spacing mm
Heating device	HEATER400	600
	HEATER800	750

NOTICE

Damage to or separation of the mains connection cable hanging down.

Secure mains connection cable against dropping during transport. ◀

- ① Fork spacing
- ② Mains connection cable

Figure 22
Transport of HEATER400 and HEATER800



Induction heating devices HEATER

Transport of HEATER1600

This device can be transported using a pallet truck or by means of a fork lift truck, *Figure 23*. The fork spacing is specified, see *table*.

Fork spacing

Component	Designation	Fork spacing mm
Heating device	HEATER1600	1 000



① Fork spacing

Figure 23
Transport of HEATER1600

Storage

The safety regulations for storage must be observed, see page 10. A heating device should be stored with protection against dust and UV radiation.

Commissioning The heating device is commissioned at the mounting area.

Hazard area The hazard area of the heating device can represent a danger of death.



Danger of heart stoppage in persons fitted with a pacemaker due to the strong electromagnetic field.

Ensure that persons fitted with a pacemaker remain outside the hazard area of the heating device. Erect barriers and attach clearly visible warning signs, *Figure 24*. ◀



Danger of death for persons with artificial heart valves made from metal, hazard of severe burns due to heating of implants by the electromagnetic field, see page 7.

Ensure that persons with a ferromagnetic implant remain outside the hazard area of the heating device. Erect barriers and attach clearly visible warning signs, *Figure 24*. ◀

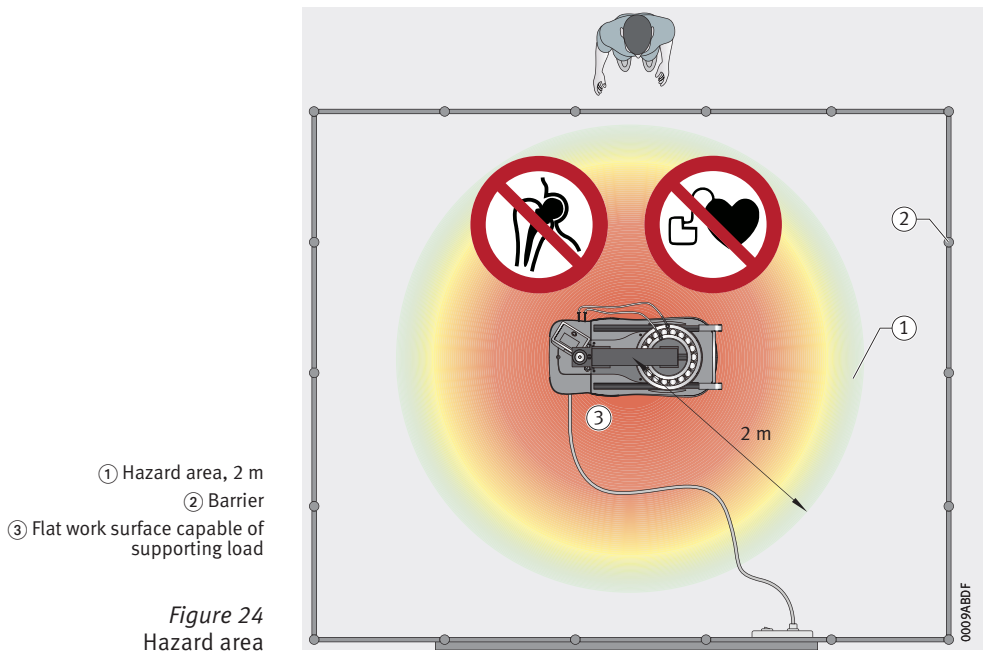

Induction heating devices HEATER

Initial stages

The first stages in commissioning are as follows:

- ▶ Remove packaging.
- ▶ Check the scope of delivery of the heating device.
- ▶ Place the heating device in a suitable mounting area.

A suitable mounting area has the following characteristics:

- flat and horizontal
- distance from ferromagnetic parts at least 1 m
- capable of supporting the total mass of the heating device and rolling bearing
- a barrier present at a distance of 2 m.

Voltage supply

Connect to voltage supply:

- ▶ Check the heating device and mains connection cable for visible damage.

⚠ DANGER

Fatal electrocution due to exposed wires as a result of melted cable sheathing.

Feed the mains connection cable around the U-shaped core.

Avoid contact between the mains connection cable and the component to be heated. ◀

- ▶ Connect the heating device to the voltage supply, *Figure 25*; *Figure 26* or *Figure 27*, page 35. For specification of the voltage supply, see nameplate, *Figure 8*, page 19, and page 71.

- ① Safety contact socket, 230 V
- ② Safety contact plug, 230 V

Figure 25
Voltage supply for
HEATER25, HEATER50 and
HEATER100

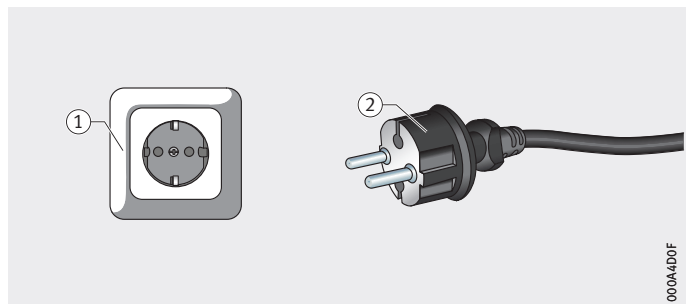

- ① CEE plug, 400 V
- ② Three-phase plug, 5 pin, 400 V

Figure 26
Voltage supply for
HEATER200, HEATER400 and
HEATER800

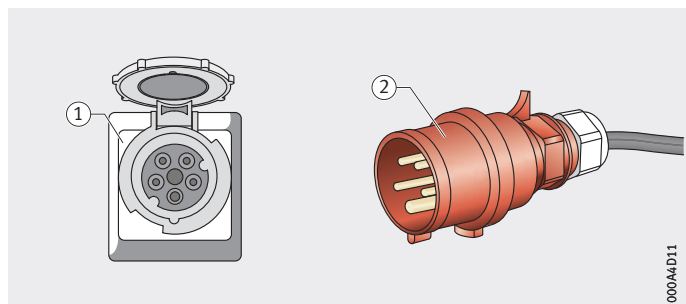

⚠ DANGER

Fatal electrocution through contact with device if mains connection has been carried out incorrectly.

Mains connection must be carried out by a trained electrician. ◀

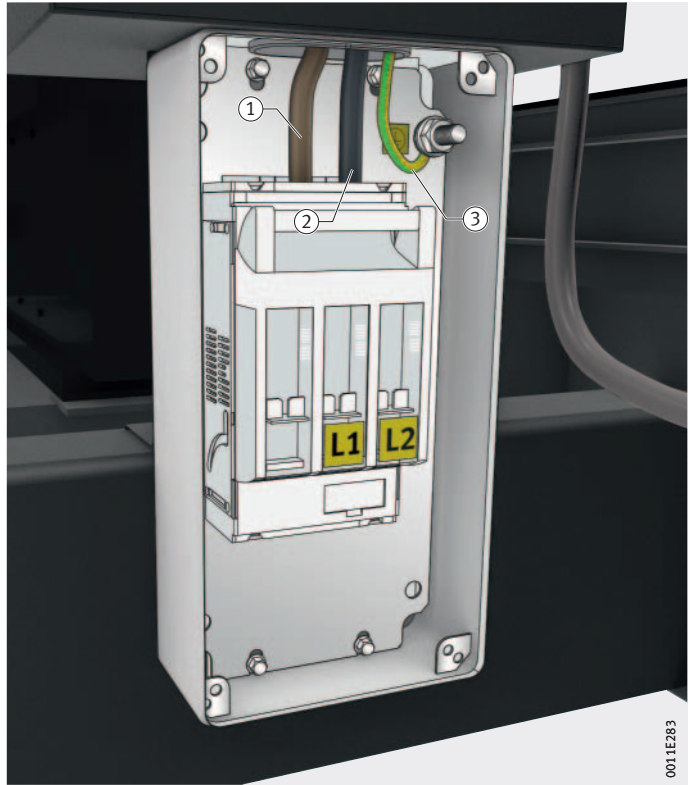

- ① Phase L1
- ② Phase L2
- ③ Protective conductor

Figure 27
Mains connection for HEATER1600

Induction heating devices HEATER

Configuration The heating device is supplied in a default configuration and is ready for immediate operation. The user can, however, configure the heating device at any time. The device has a configuration menu. The USB connector can be used for loading new firmware or other user languages, see page 39.

USB connector A USB connector is present below the touch-sensitive screen, *Figure 28*.

The following media can be used:

- USB2.0 stick (up to 32 GB, FAT).

① USB2.0 connector

Figure 28
USB connector



Configuration menu

The configuration menu contains a list of parameters that influence the behaviour of the device, *Figure 29*.

The configuration menu is called up as follows:

- ▶ Press **[START/STOP]** for at least 8 seconds.

- ① **[START/STOP]**
- ② **[Arrow up]**
- ③ **[Arrow down]**
- ④ **[Apply]**
- ⑤ **[Cancel]**

Figure 29
Key and symbols



A parameter is selected and adjusted by means of symbols on the touch-sensitive screen, see *table*.

Symbols

Designation	Function
[Arrow up]	1: Change to previous parameter 2: Increase value
[Arrow down]	1: Change to next parameter 2: Reduce value
[Apply]	Confirm modified value and go back to parameter list
[Cancel]	Undo changes and go back to parameter list

Induction heating devices HEATER

Updating the firmware

A firmware update is only possible via the USB connector:

- ▶ Copy the current firmware to your Windows PC from www.schaeffler.de/heater-software.
- ▶ Check whether the current firmware is already installed (U29), see page 47.
- ▶ Format a USB stick, see page 36. There must be no other files on the USB stick.
- ▶ Copy the following files onto the USB stick (top level)
 - BOOTGUI.BIN
 - BOOTGUI_DD-MMM-YYYY FAG v* build *.BIN.
- ▶ Connect the USB stick.
- ▶ Press [**START/STOP**] for at least 8 seconds.
- ▶ Scroll to parameter U26.
- ▶ Select the parameter on the screen.
- ▶ When the security question appears, click on [**Apply**].
- ▷ The firmware will now be updated, *Figure 30*.

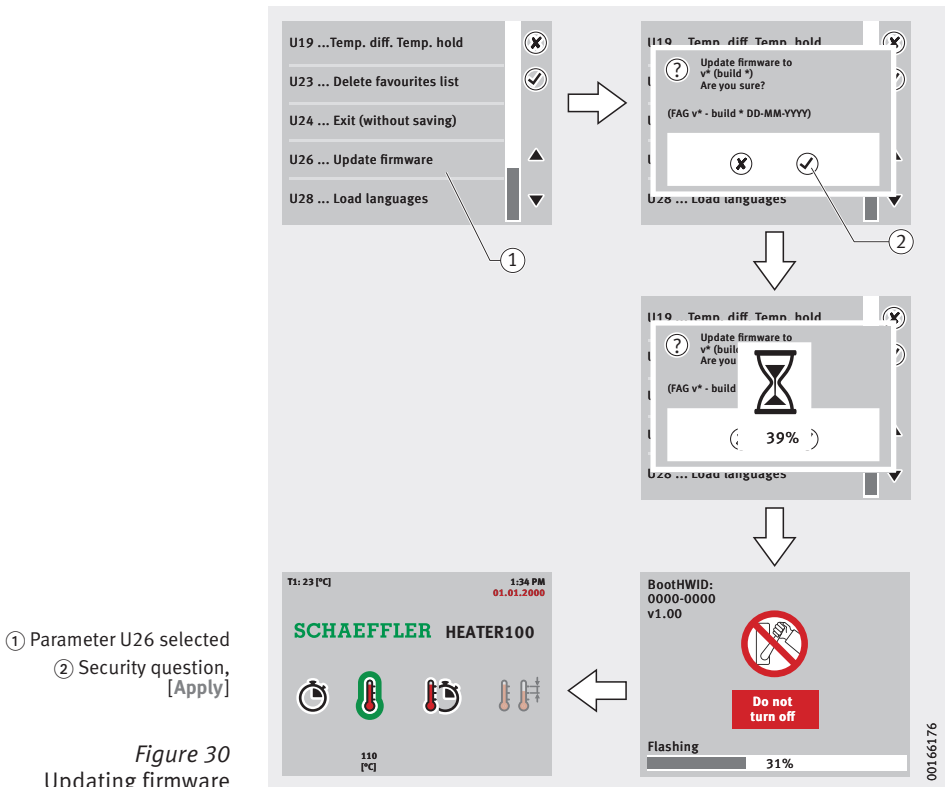

User languages	The control unit can simultaneously store up to 32 user languages.
Deleting a user language	The user languages cannot be individually deleted. Whenever the user languages are installed, all the languages present on the device are deleted. The languages present in the language package are then installed.

Induction heating devices HEATER

Copying user languages

The control unit can simultaneously store up to 32 user languages. These are installed as a package.

After a firmware update, the user languages must always be copied again.

Copy the user languages to the device:

- ▶ Copy the language package to your Windows PC from www.schaeffler.de/heater-software.
- ▶ Format a USB stick, see page 36. There must be no other files on the USB stick.
- ▶ Copy the following files onto the USB stick (top level)
 - FONTS_DD-MMM-YYYY_v*.BIN
 - TEXT_DD-MMM-YYYY_v*_*.BIN.
- ▶ Connect the USB stick.
- ▶ Press [**START/STOP**] for at least 8 seconds.
- ▶ Scroll to parameter U28.
- ▶ Select the parameter on the screen.
- ▶ When the security question appears, click on [**Apply**].
- ▷ The languages will now be copied, *Figure 31*.

- ① Parameter U28 selected
- ② Security question, [Apply]

Figure 31
Copying user languages

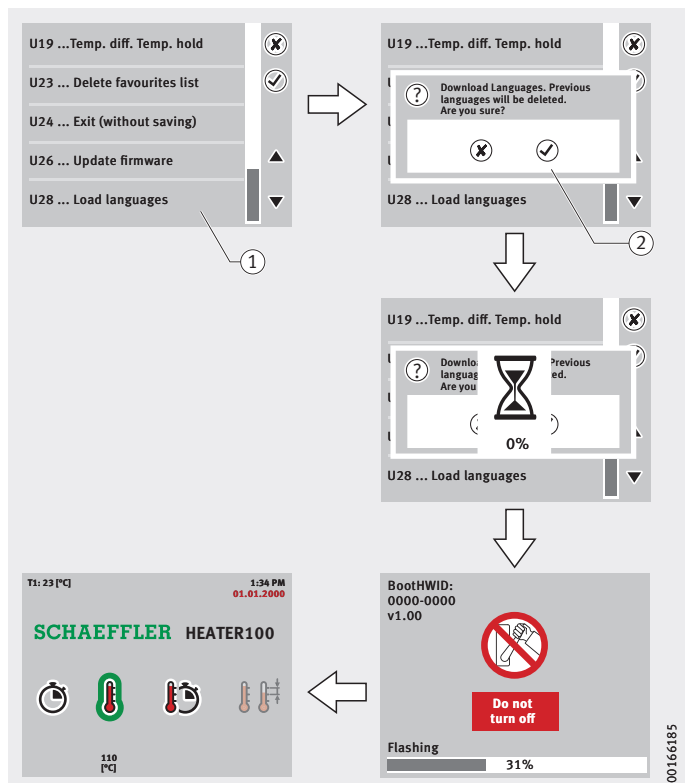

00166185

Parameters

The behaviour of the device can be set by means of parameters. During configuration, the heating device is set to user mode.

There are three different types of parameters, see *table*, page 42:

- setting parameters
- command parameters
- information parameters.

A setting parameter sets and permanently saves a value. In order to change the value set in this way, the parameter must be called up again.

With a command parameter, selecting the parameter gives a command that initiates control of the device.

An information parameter saves values that can be called up.

Induction heating devices HEATER

Overview of parameters

Dimension	Definition	S	C	I
U00	Resetting to device default setting	-	●	-
U01	User language	●	-	-
U02	Default setting for heating temperature	●	-	-
U03	Temperature hold on/off	●	-	-
U04	Temperature hold time	●	-	-
U05	Signal for end of heating operation	●	-	-
U06	Unit for temperature	●	-	-
U07	Temperature differential delta-T	●	-	-
U08	...	-	-	-
U09	Calibration temperature of temperature sensor 1	●	-	-
U10	Calibration temperature of temperature sensor 2	●	-	-
U11	...	-	-	-
U12	Start delay	●	-	-
U13	Diagram of temperature pattern	-	-	●
U14	Screensaver	●	-	-
U15	Time	●	-	-
U16	Date	●	-	-
U17	...	-	-	-
U18	Time format	●	-	-
U19	Temperature differential in temperature hold	●	-	-
U20	...	-	-	-
U21	...	-	-	-
U22	...	-	-	-
U23	Deleting the favourites list	-	●	-
U24	Exit	-	●	-
U25	...	-	-	-
U26	Updating firmware	-	●	-
U27	...	-	-	-
U28	Loading languages	-	●	-
U29	Firmware version	-	-	●
U30	Number of heating operations	-	-	●
U31	Total heating time	-	-	●

S: Setting parameter

C: Command parameter

I: information parameter

Resetting to device default setting U00	<p>The heating device is supplied with default settings for the parameters and a specific firmware. The heating device can be restored to this default setting at any time. This parameter resets all other parameters to the default settings. The firmware is also activated again at delivery and updates to the firmware are deleted.</p> <p>Setting options:</p> <ul style="list-style-type: none"> <input type="checkbox"/> Device default setting on (default setting) <input type="checkbox"/> Device default setting off.
User language U01	<p>The heating device is supplied with several user languages. This parameter is used to select one of the available user languages as the current user language.</p> <p>User language:</p> <ul style="list-style-type: none"> <input type="checkbox"/> English <input type="checkbox"/> German <input type="checkbox"/> Dutch <input type="checkbox"/> ...
Default setting for heating temperature U02	<p>The heating temperature is the temperature to which the rolling bearing is heated. If the operating mode of the heating device is temperature control, the heating temperature last used is shown in the display when it is switched on.</p> <p>Heating temperature:</p> <ul style="list-style-type: none"> <input type="checkbox"/> +50 °C, 122 °F Minimum value <input type="checkbox"/> +110 °C, 230 °F Default setting <input type="checkbox"/> +240 °C, 464 °F Maximum value <input type="checkbox"/> 1 Step size.

Induction heating devices HEATER

Temperature hold on/off U03	Once the heating temperature is achieved, the heating device stops the heating operation. The rolling bearing starts to cool down. If the temperature is below a certain temperature value, the bearing is heated again. The time duration of temperature hold can be set using the parameter U04. Setting options: <ul style="list-style-type: none">■ Temperature hold on (default setting)■ Temperature hold off.
Temperature hold time U04	After the set time, temperature hold is switched off and the rolling bearing cools down. Values and step size: <ul style="list-style-type: none">■ 0 s Minimum value■ 0 s Default setting■ 30 s Delivered condition■ 99 h:59 min:59 s Maximum value■ 1 Step size.
Signal for end of heating operation U05	The end of the heating operation is always displayed optically on the touch-sensitive screen but can also be displayed by acoustic means. Setting options: <ul style="list-style-type: none">■ Signal for end of heating operation on (default setting)■ Signal for end of heating operation off.
Unit for temperature U06	The measured temperature is shown in the selected unit. Units: <ul style="list-style-type: none">■ Display in °C (default setting)■ Display in °F.
Temperature differential delta-T U07	This value is the maximum permissible temperature differential in delta-T control. The temperature differential results from the comparison of the temperatures measured by temperature sensor 1 and temperature sensor 2. Values and step size: <ul style="list-style-type: none">■ 1 °C, 33,8 °F Minimum value■ +35 °C, 95 °F Default setting■ +100 °C, 212 °F Maximum value■ 1 Step size.

<p>Calibration temperature of temperature sensor 1 U09</p>	<p>Before a new temperature sensor is used for the first time, it should be calibrated. Calibration is a point calibration. It is therefore advantageous if calibration is carried out at the heating temperature. The temperature of the sensor head is recorded using an adjusted temperature gauge. This temperature is inputted as the calibration temperature.</p> <p>Values and step size:</p> <ul style="list-style-type: none"> ■ +10 °C, 50 °F Minimum value ■ +42 °C, 107,6 °F Maximum value ■ 1 Step size.
<p>Calibration temperature of temperature sensor 2 U10</p>	<p>Before a new temperature sensor is used for the first time, it should be calibrated. Calibration is a point calibration. It is therefore advantageous if calibration is carried out at the heating temperature. The temperature of the sensor head is recorded using an adjusted temperature gauge. This temperature is inputted as the calibration temperature.</p> <p>Values and step size:</p> <ul style="list-style-type: none"> ■ +9 °C, 48,2 °F Minimum value ■ +41 °C, 105,8 °F Maximum value ■ 1 Step size.
<p>Start delay U12</p>	<p>The heating device does not start heating immediately after pressing [START/STOP]. The start delay is the time that passes after pressing [START/STOP] until the heating device starts heating.</p> <p>Values and step size:</p> <ul style="list-style-type: none"> ■ 5 s Minimum value ■ 5 s Default setting ■ 30 s Delivered condition ■ 99 s Maximum value ■ 1 Step size.
<p>Diagram of temperature pattern U13</p>	<p>The last heating curve saved by the device is displayed. The values from which the heating curve was generated can be saved as a file (.csv).</p>

Induction heating devices HEATER

Screensaver U14	<p>The screensaver for the touch-sensitive screen can be switched off by inputting the minimum value.</p> <p>Values and step size:</p> <ul style="list-style-type: none">■ 0 min Minimum value■ 10 min Default setting■ 10 min Delivered condition■ 240 min Maximum value■ 1 Step size.
Time U15	<p>The time is given in hours (h) and minutes (min).</p> <p>Values and step size:</p> <ul style="list-style-type: none">■ 00 h:00 min Default setting■ 23 h:59 min Maximum value with 24 h■ 11 h:59 min Maximum value with 12 h AM/PM■ 1 Step size.
Date U16	<p>The date is displayed in accordance with DIN 5008 in the format (day.month.year).</p> <p>Delivered condition and step size:</p> <ul style="list-style-type: none">■ 01.01.2000 Delivered condition■ 1 Step size.
Time format U18	<p>Display of the time can be selected as one of two formats.</p> <p>Formats:</p> <ul style="list-style-type: none">■ 24 h Default setting■ 12 h AM/PM US format.
Temperature differential in temperature hold U19	<p>If temperature hold is switched on, the device will carry out heating again if the temperature decreases by this value.</p>
Deleting the favourites list U23	<p>All favourites can be deleted using this command parameter.</p> <p>Setting options:</p> <ul style="list-style-type: none">■ Delete favourites list (default setting)■ Do not delete favourites list.

Exit U24	<p>The configuration menu is exited and the changes to parameters are not saved.</p> <p>Setting options:</p> <ul style="list-style-type: none"> <input type="checkbox"/> Exit (default setting) <input type="checkbox"/> Do not exit.
Updating firmware U26	<p>This command parameter starts an update of the firmware. The system checks whether the firmware on the USB stick is more up to date than the existing firmware.</p> <p>Setting options:</p> <ul style="list-style-type: none"> <input type="checkbox"/> Update (default setting) <input type="checkbox"/> Do not update. <p>Note This parameter only appears in the list of parameters if a USB stick is inserted.</p>
Loading languages U28	<p>This command parameter starts loading of a language package. All the existing languages are deleted and the user languages in the language package are installed. An individual language package can be created; please contact Customer Service in this case.</p> <p>Setting options:</p> <ul style="list-style-type: none"> <input type="checkbox"/> Load languages (default setting) <input type="checkbox"/> Do not load languages. <p>Note If a language package is loaded, all the existing user languages will be deleted.</p> <p>This parameter only appears in the list of parameters if a USB stick is inserted.</p>
Firmware version U29	<p>This parameter shows the currently installed version of the firmware. Before installing firmware, it can thus be checked whether the most up to date version of the firmware is already installed.</p>
Number of heating operations U30	<p>This parameter displays the number of heating operations that have been performed by this device. This information may be useful in searching for errors.</p>
Total heating time U31	<p>This parameter displays the time for which the device was in operation during all heating operations. This information may be useful in searching for errors.</p>

Induction heating devices HEATER

Operation It is recommended that only one rolling bearing should ever be heated at one time.

A heating operation comprises the following stages:

- Select the suitable heating device
- Select and if necessary change the ledge
- Position the rolling bearing
- Attach the temperature sensor
- Select the heating method
- Set the values
- Carry out heating
- Remove the temperature sensor
- Remove the rolling bearing
- Save the heating curve (optional).

Selecting a heating device Not all rolling bearings are suitable for these heating devices. The mass and dimensions must fulfil certain values.



Risk of injury due to tilting of heating device and falling rolling bearing.

Ensure that the permissible masses and dimensions are observed, see *table*. ◀

Mass and dimensions

Designation	Mass		Inside diameter min. mm	Outside diameter max. mm	Width max. mm
	Rolling bearing max. kg	Other component max. kg			
HEATER25	25	20	10	400	120
HEATER50	50	40	10	400	120
HEATER100	100	80	15	500	180
HEATER200	200	150	20	600	210
HEATER400	400	300	40	1 000	330
HEATER800	800	600	50	1 500	400
HEATER1600	1 600	1 200	90	2 000	650

Selecting a support ledge If a support ledge is used whose cross-section is too small, the heating device cannot carry out heating at full power:
 ► Select the support ledge with the largest possible cross-section.

Changing the slewing ledge

Before heating, the slewing ledge with the largest possible cross-section is selected. When using a support ledge, the slewing ledge present is removed but a new slewing ledge is not put in place.

Lifting off the slewing ledge

Lift off the slewing ledge, *Figure 32*:

- ▶ Switch off the heating device using the main switch.
- ▶ Lift the slewing ledge upwards off the locating stud.
- ▶ Place the slewing ledge on the work surface next to the heating device.
- ▶ Grease the contact surfaces.

- ① Slewing ledge
- ② Locating stud

Figure 32

Lifting off the slewing ledge

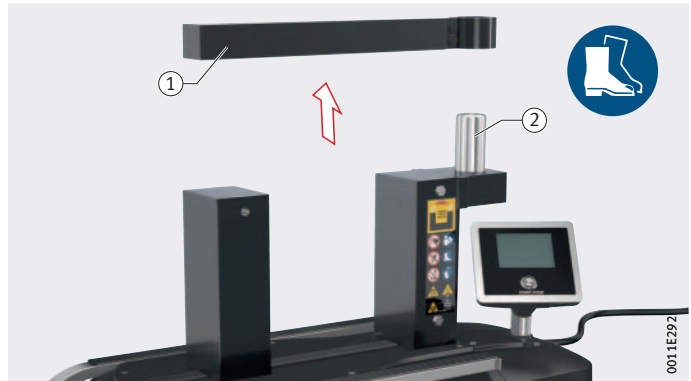

Locating the slewing ledge

Locate the slewing ledge, *Figure 33*:

- ▶ Place the new slewing ledge from above on the locating stud.
- ▶ Position the slewing ledge on the U-shaped core.
- ▷ The slewing ledge has been changed.

- ① Slewing ledge
- ② U-shaped core

Figure 33

Locating the slewing ledge

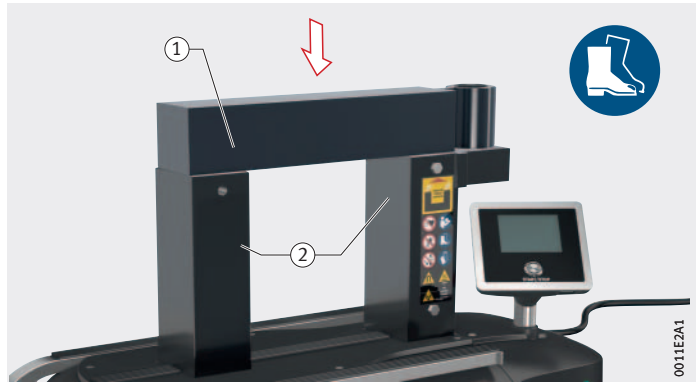

Induction heating devices HEATER

Changing the vertical ledge

Before heating, the vertical ledge with the largest possible cross-section is selected.

Removing the vertical ledge

Remove the vertical ledge, *Figure 34*:

- ▶ Switch off the heating device using the main switch.
- ▶ Lift the vertical ledge away from the ledge guide using a suitable lifting device.
- ▶ Place the vertical ledge on the work surface next to the heating device.
- ▶ Grease the contact surfaces and guide of the vertical ledge to be mounted as well as the contact surfaces on the U-shaped core.

- ① Vertical ledge
- ② Grip

Figure 34

Removing the vertical ledge

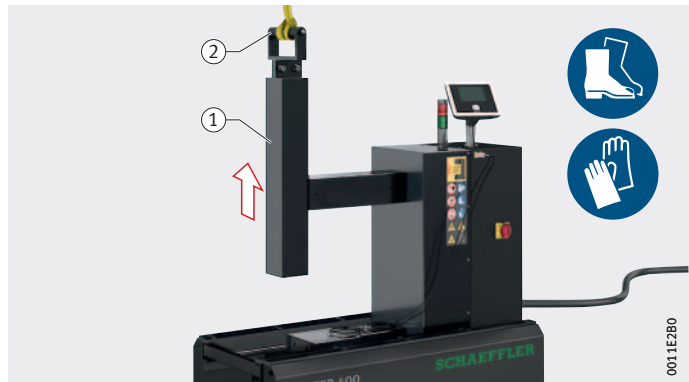

Mounting the vertical ledge

Mount the vertical ledge, *Figure 35*:

- ▶ Mount the vertical ledge from above in the ledge guide using a suitable lifting device.
- ▷ The vertical ledge has been changed.

- ① Vertical ledge
- ② U-shaped core

Figure 35

Mounting the vertical ledge

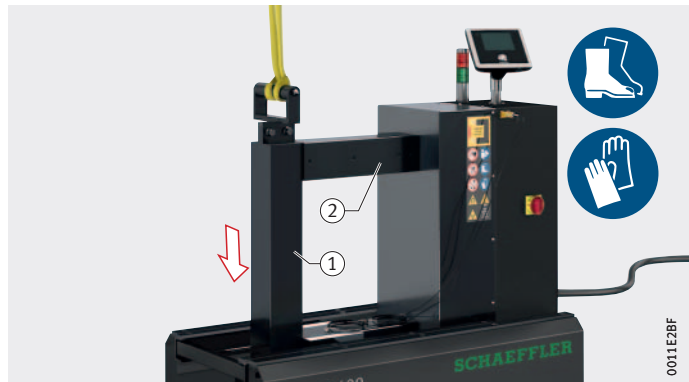

Positioning the rolling bearing

Depending on the heating device used, the rolling bearing can be positioned either suspended or lying flat, see *table*.

Positioning

Designation	Support ledge		Slewing ledge		Vertical ledge
	Suspended	Lying flat	Suspended	Lying flat	Lying flat
HEATER25	●	●	–	–	–
HEATER50	●	●	–	–	–
HEATER100	●	●	●	●	–
HEATER200	●	●	●	●	–
HEATER400	–	–	–	–	●
HEATER800	–	–	–	–	●
HEATER1600	–	–	–	–	●

Support ledge: positioning the rolling bearing suspended

Position the rolling bearing on the heating device, *Figure 36*:

NOTICE

Damage to the heating device due to overloading of the support ledge.

Observe the maximum mass of the rolling bearing, see *table*. ◀

- ▶ Remove the slewing ledge if necessary.
- ▶ Grease the support surfaces.
- ▶ Slide the rolling bearing onto the support ledge.
- ▶ Lay the support ledge with the rolling bearing on the U-shaped core.
- ▷ The rolling bearing is positioned suspended from the support ledge.

Mass, maximum

Designation		Mass max. kg
Heating device	Support ledge	
HEATER25, HEATER50	HEATER50.LEDGE-10	0,5
	HEATER50.LEDGE-15	1
	HEATER50.LEDGE-20	3
HEATER100	HEATER100.LEDGE-15	1
	HEATER100.LEDGE-20	3
HEATER200	HEATER200.LEDGE-20	3

- ① Rolling bearing
- ② Support ledge

Figure 36
Rolling bearing suspended,
support ledge

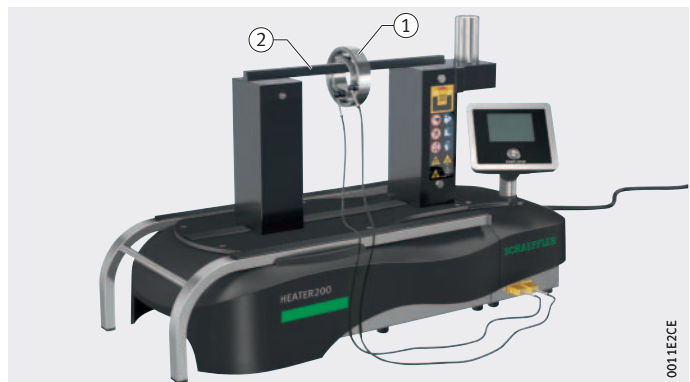

0011E2CE

Induction heating devices HEATER

Slewing ledge: positioning the rolling bearing suspended

Position the rolling bearing, *Figure 37*:

⚠ WARNING

Risk of injury due to tilting of heating device and falling rolling bearing.

In the case of heavy rolling bearings, use a suitable carrying sling and a suitable lifting device, then slide the rolling bearing to the end of the slewing ledge during positioning. ◀

NOTICE

Damage to the heating device due to overloading of the open slewing ledge.

Observe the maximum mass for open slewing ledges, see *table*. ◀

- ▶ Rotate the slewing ledge away from the U-shaped core.
- ▶ Slide the rolling bearing onto the slewing ledge.
- ▶ Rotate the slewing ledge with the rolling bearing until the slewing ledge is fully located on the U-shaped core.
- ▶ Lower the rolling bearing.
- ▶ Remove the carrying sling.
- ▷ The rolling bearing is positioned suspended from the slewing ledge.

Mass, maximum

Designation	Mass max. kg
HEATER100	20
HEATER200	30

- ① Rolling bearing
- ② Slewing ledge

Figure 37
Rolling bearing suspended,
slewing ledge

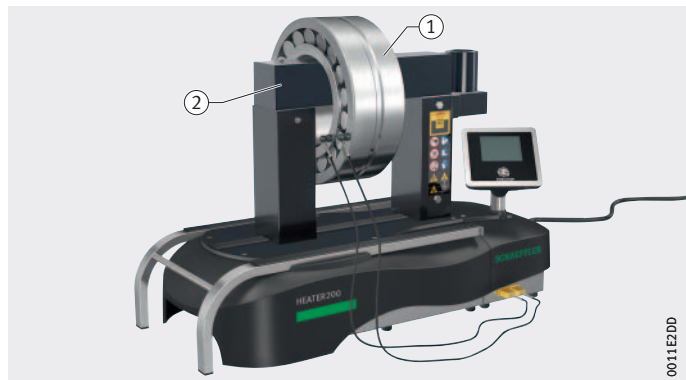

**Support ledge:
positioning the rolling bearing
lying flat**

Position the rolling bearing, *Figure 38*:

- ▶ Remove the slewing ledge if necessary.
- ▶ Slide the sliding table out so that the sliding table supports the outer ring of the rolling bearing.
- ▶ Lay the rolling bearing on the sliding table.
- ▶ Lay the support ledge centrally on the U-shaped core.
- ▷ The rolling bearing is positioned lying flat.

- ① Support ledge
- ② U-shaped core
- ③ Rolling bearing
- ④ Sliding table

Figure 38
Rolling bearing lying flat,
support ledge



0011E2EC

**Slewing ledge:
positioning the rolling bearing
lying flat**

Position the rolling bearing, *Figure 39*:

- ▶ Rotate the slewing ledge away from the U-shaped core.
- ▶ Slide the sliding table out so that the sliding table supports the outer ring of the rolling bearing.
- ▶ Lay the rolling bearing on the sliding table.
- ▶ Rotate the slewing ledge so that it is fully located on the U-shaped core.
- ▷ The rolling bearing is positioned lying flat.

- ① Slewing ledge
- ② U-shaped core
- ③ Rolling bearing
- ④ Sliding table

Figure 39
Rolling bearing lying flat,
slewing ledge

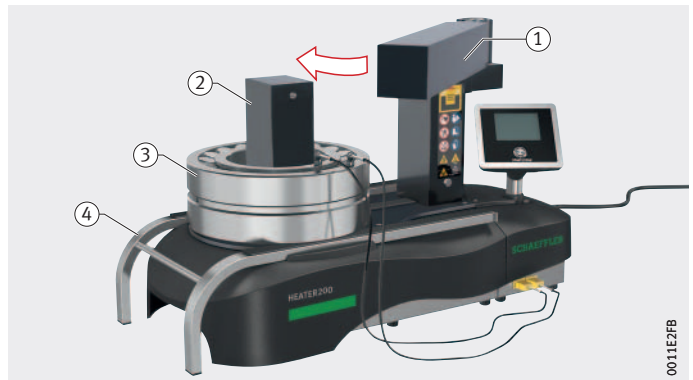

0011E2FB

Induction heating devices HEATER

Vertical ledge: positioning the rolling bearing lying flat

Position the rolling bearing, *Figure 40*:

⚠ WARNING

Risk of injury due to tilting of heating device and falling rolling bearing.

For rolling bearings and other heavy workpieces, always use the sliding table. Use a suitable carrying sling and a suitable lifting device for the vertical ledge. ◀

- ▶ Slide the sliding table out so that the sliding table supports the outer ring of the rolling bearing.
- ▶ Lift the vertical ledge using a suitable lifting device.
- ▶ Position the rolling bearing by means of the sliding table so that the vertical ledge can be lowered through the inner ring onto the U-shaped iron core.
- ▶ Lower the vertical ledge and remove the carrying sling.
- ▷ The rolling bearing is positioned.

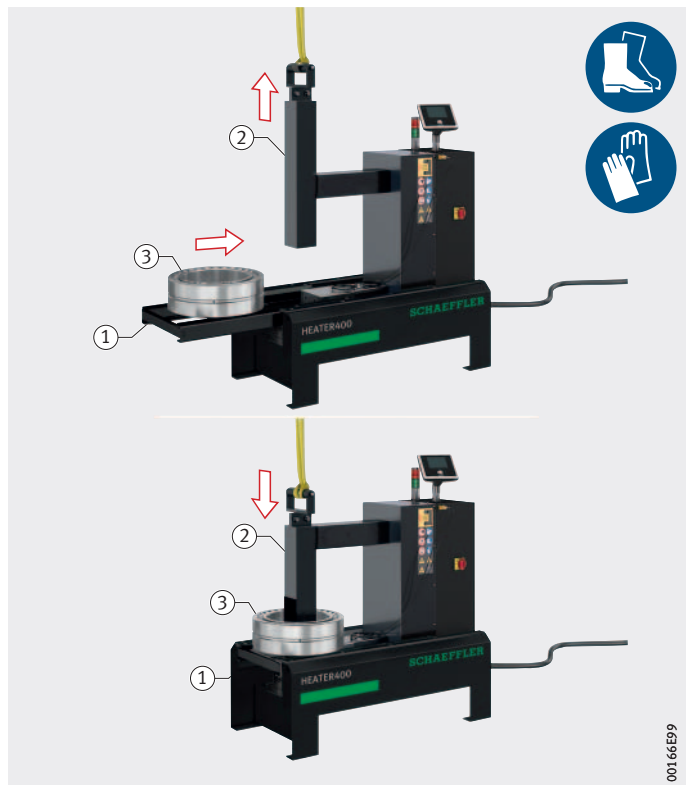

Connecting the temperature sensor

Temperature sensors

Except in the operating mode of time control, at least one temperature sensor must be used, see *table*.

Heating method	Temperature sensor	
	Inner ring	Outer ring
Time control	–	–
Temperature control	●	–
Ramp control	●	–
Delta-T control	●	●

Connecting and attaching one temperature sensor

Connect and attach one temperature sensor, *Figure 41*:

NOTICE

Destruction of the temperature sensor through heating of the cable, leading to melting of the cable sheathing.

Feed the temperature sensor cable around the U-shaped core. ◀

- ▶ Insert the plug of the temperature sensor with the red mark facing upwards in one of the two sockets.
- ▶ Place the magnetic sensor head of the temperature sensor on the end face, which must be free from grease and oil, of the inner ring.
- ▷ The temperature sensor is connected and attached and the temperature can be measured.

- ① Inner ring of rolling bearing
- ② Sensor head of temperature sensor
- ③ Cable of temperature sensor
- ④ Socket for temperature sensor
- ⑤ Plug of temperature sensor

Figure 41
Connecting and attaching the temperature sensor

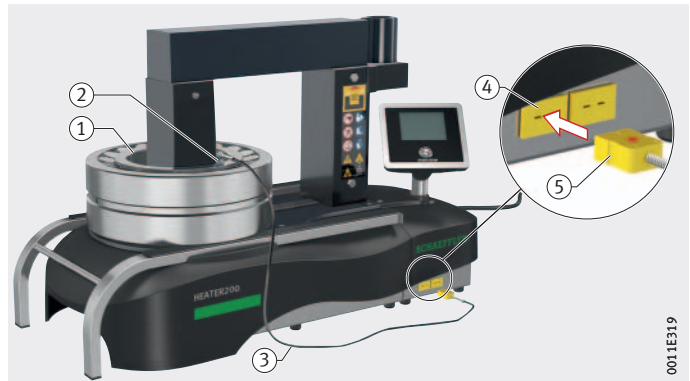

0011E319

Induction heating devices HEATER

Connecting and attaching two temperature sensors

Connect and attach two temperature sensors, *Figure 42*:

NOTICE

Destruction of the temperature sensors through heating of the cable, leading to melting of the cable sheathing.

Feed the temperature sensor cable around the U-shaped core. ◀

- ▶ Insert the plug of one temperature sensor with the red mark facing upwards in one of the two sockets.
 - ▶ Place the magnetic sensor head of the temperature sensor on the end face, which must be free from grease and oil, of the inner ring.
 - ▶ Insert the plug of the other temperature sensor with the red mark facing upwards in the socket not used yet.
 - ▶ Place the magnetic sensor head of the temperature sensor on the end face, which must be free from grease and oil, of the outer ring.
- ▷ The temperature sensors are connected and attached and the temperatures can be measured.

- ① Inner ring of rolling bearing
- ② Sensor head on inner ring
- ③ Cable of temperature sensor
- ④ Socket for temperature sensor
- ⑤ Plug of temperature sensor
- ⑥ Outer ring of rolling bearing
- ⑦ Sensor head on outer ring

Figure 42
Connecting and attaching the temperature sensor

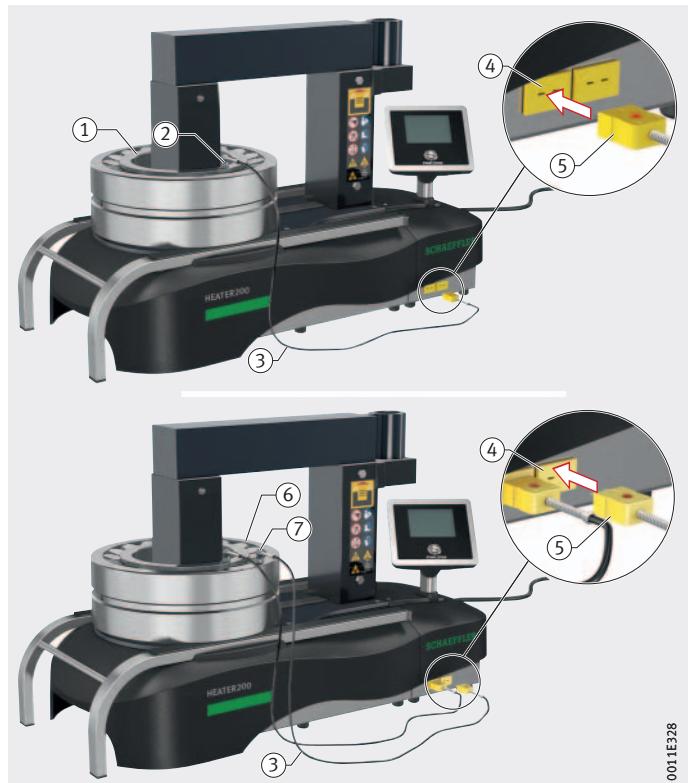

001E328

Selecting the heating method

- ▶ Switch on the heating device using the main switch.
- ▶ If the symbol for the heating method (in this case [**Temperature control**]) does not have a green border, click on the symbol.
- ▷ The symbol will be shown with a green border and the preset values (in this case the heating temperature) will be displayed.
- ▶ Click on the value displayed (in this case the heating temperature).
- ▷ The screen with the values for this heating method (in this case the heating temperature) will be displayed, *Figure 43*.

- ① Symbol [Temperature control]
- ② Set heating temperature

Figure 43
Setting

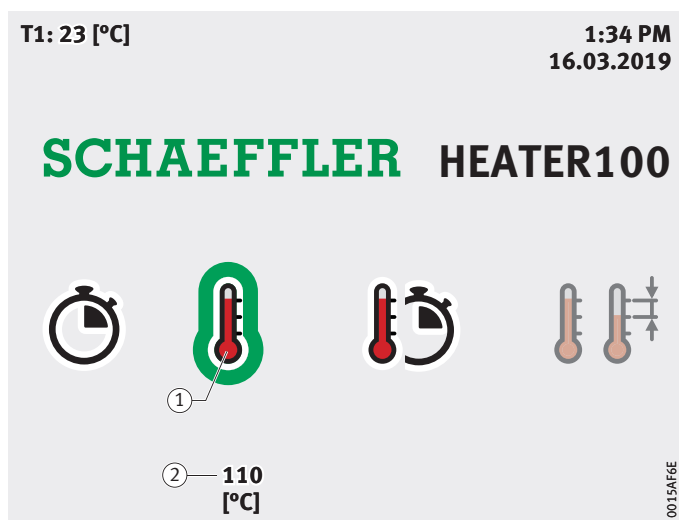

Induction heating devices HEATER

Setting values

A heating operation by means of temperature control is described here. Heating by one of the other heating methods is carried out according to the same system.

- ▶ Set the value (in this case the heating temperature) by means of [Arrow up] and [Arrow down], *Figure 44*.
- ▶ Click on [Apply].
- ▷ The value will be accepted and the start screen will be displayed.

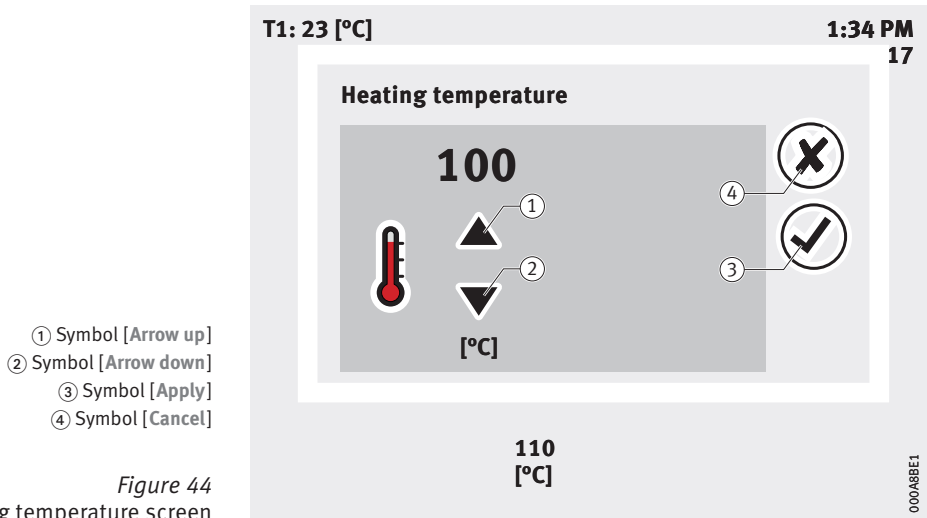

Serious injuries due to destroyed heating device with heating of the component to more than +240 °C.

Restrict the heating temperature to +240 °C. <

Heating

- ▶ Press [**START/STOP**].
- ▷ The countdown time is counted down, *Figure 45*.
- ▶ Move out of the hazard area of the heating device and observe the safe distance while the heating device is heating the rolling bearing.



Figure 45
Countdown

- ▶ Wait for the end of the countdown time.
- ▷ The temperature will be displayed, the electromagnetic field will be generated and the heating operation will start.
- ▶ Wait until the temperature is reached.

Induction heating devices HEATER

Cancelling temperature hold

If temperature hold is switched on, this can be cancelled before it stops itself.

There is normally sufficient time to reach the heating device and activate [START/STOP]. If the countdown time has been set to a low value and the rolling bearing is cooling very quickly, the countdown may start while the user is still in the hazard area.



Risk of damage to health from remaining in the electromagnetic field.

Leave the hazard area of the heating device and observe the safe distance if the countdown time is being counted down. ◀

- ▶ From a safe distance, check whether the touch-sensitive screen is displaying a white tick in a green circle and the text Heating operation ended, *Figure 46*.
- ▶ Press [START/STOP] to end temperature hold. The heated rolling bearing can be removed.

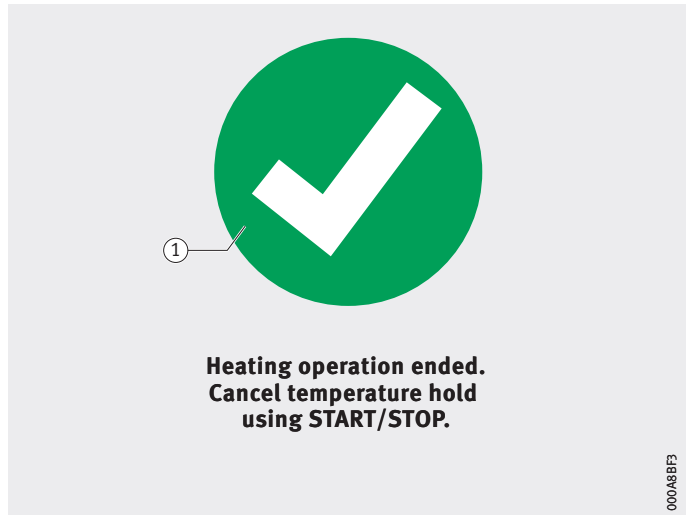

① Symbol Heating operation ended

Figure 46
Heating operation ended

Removing the temperature sensor

Removing one temperature sensor

In order to protect the temperature sensor against damage, it should be removed before removing the rolling bearing.

Remove the temperature sensor, *Figure 47*:

- ▶ Grip the temperature sensor by its sensor head.
- ▶ Detach the sensor head from the end face of the inner ring.
- ▶ Where necessary, pull the plug of the temperature sensor out of the socket.

- ① Inner ring of rolling bearing
- ② Sensor head of temperature sensor
- ③ Cable of temperature sensor
- ④ Socket for temperature sensor
- ⑤ Plug of temperature sensor

Figure 47
Removing the temperature sensor

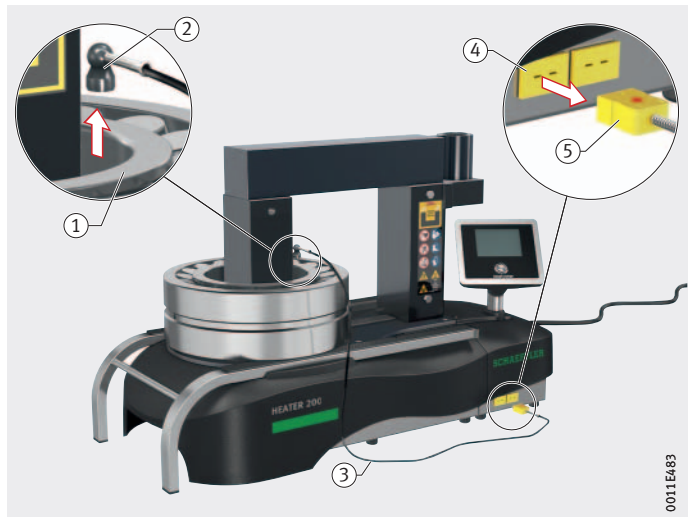

Induction heating devices HEATER

Removing the rolling bearing

Support ledge: removing the suspended rolling bearing

Once the temperature sensor or sensors have been detached, the rolling bearing can be removed.

Remove the rolling bearing, *Figure 48*:

⚠ WARNING

Severe burns to hands due to touching the hot workpiece without protective gloves.

Wear gloves that are heat-resistant up to +250 °C. <

⚠ WARNING

Severe foot injuries due to falling ledge or falling rolling bearing.

Wear safety shoes. <

- ▶ Lift the rolling bearing and the support ledge together off the U-shaped core.
- ▶ Remove the support ledge from the rolling bearing and lay both down separately.
- ▷ The rolling bearing can now be mounted.

- ① Rolling bearing
- ② Support ledge
- ③ U-shaped core

Figure 48
Removing the suspended
rolling bearing
from the support ledge

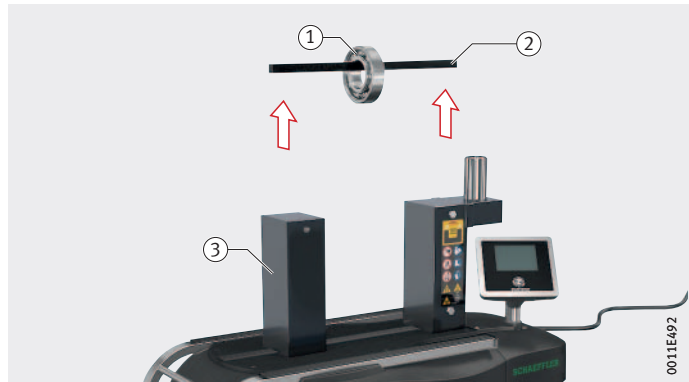

**Slewing ledge:
removing the suspended
rolling bearing**

Remove the rolling bearing, *Figure 49*:

⚠ WARNING

Severe burns to hands due to touching the hot workpiece without protective gloves.

Wear gloves that are heat-resistant up to +250 °C. ◀

⚠ WARNING

Severe foot injuries due to falling ledge or falling rolling bearing.

Wear safety shoes. ◀

- ▶ Lift heavy rolling bearings by means of a carrying sling and suitable lifting device.
- ▶ Rotate the rolling bearing and slewing ledge away from the U-shaped core.
- ▶ Slide the rolling bearing off the slewing ledge.
- ▷ The rolling bearing can now be mounted.

- ① Rolling bearing
- ② Slewing ledge
- ③ U-shaped core

Figure 49
Removing the suspended
rolling bearing
from the slewing ledge

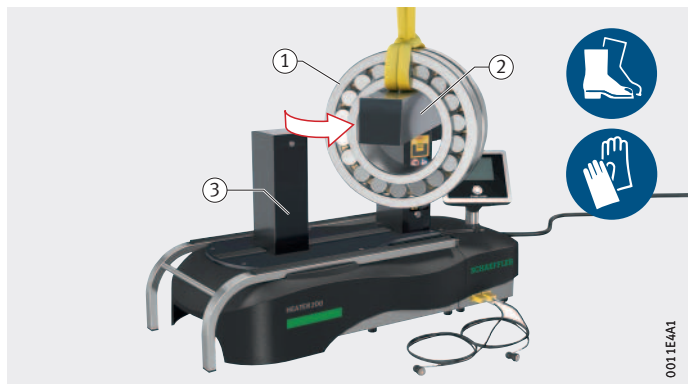

Induction heating devices HEATER

Slewing ledge: removing the rolling bearing lying flat

Remove the rolling bearing, *Figure 50*:

⚠ WARNING

Severe burns to hands due to touching the hot workpiece without protective gloves.

Wear gloves that are heat-resistant up to +250 °C. ◀

⚠ WARNING

Severe foot injuries due to falling ledge or falling rolling bearing.

Wear safety shoes. ◀

▶ Rotate the slewing ledge away from the U-shaped core.

▶ Remove the rolling bearing.

▷ The rolling bearing can now be mounted.

- ① Rolling bearing
- ② Slewing ledge
- ③ U-shaped core

Figure 50
Removing the rolling bearing
lying flat

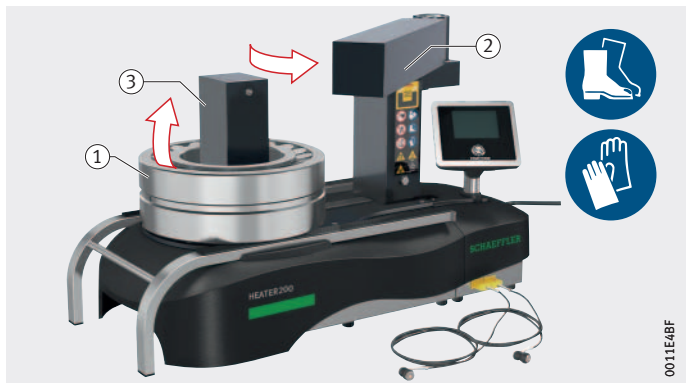

**Vertical ledge:
removing the rolling bearing
lying flat**

Remove the rolling bearing, *Figure 51*:

⚠ WARNING

Severe burns to hands due to touching the hot workpiece without protective gloves.

Wear gloves that are heat-resistant up to +250 °C. ◀

⚠ WARNING

Severe foot injuries due to falling ledge or falling rolling bearing.

Wear safety shoes. ◀

- ▶ Lift the vertical ledge using a suitable lifting device.
- ▶ Remove the rolling bearing from the heating device by means of the sliding table.
- ▶ Lower the vertical ledge.
- ▶ Lift the rolling bearing off the sliding table.
- ▷ The rolling bearing can now be mounted.

- ① Sliding table
- ② Vertical ledge
- ③ Rolling bearing

Figure 51
Removing the rolling bearing

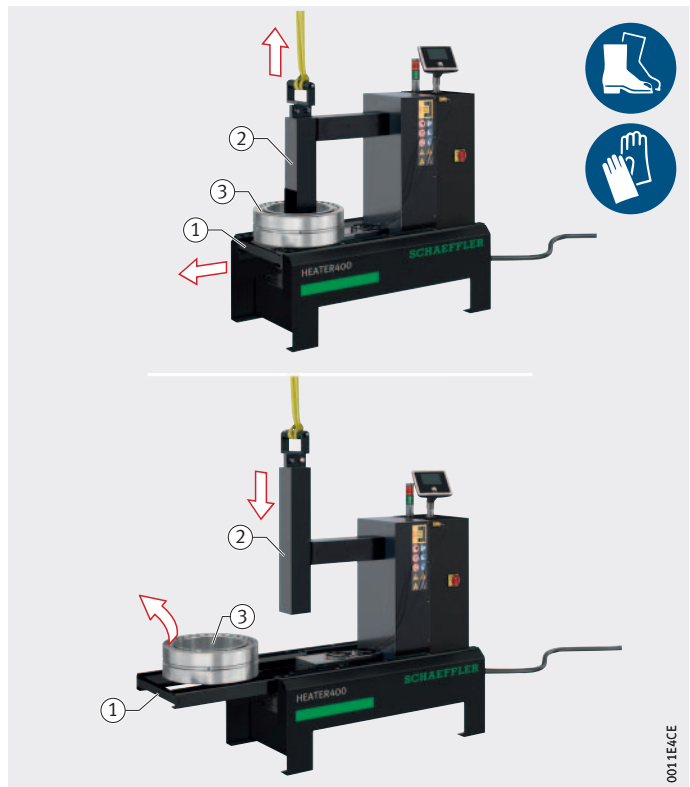

Induction heating devices HEATER

Saving the heating curve ► Click on the symbol [Display heating curve], *Figure 52*.

① Symbol [Display heating curve]

Figure 52
Displaying the heating curve

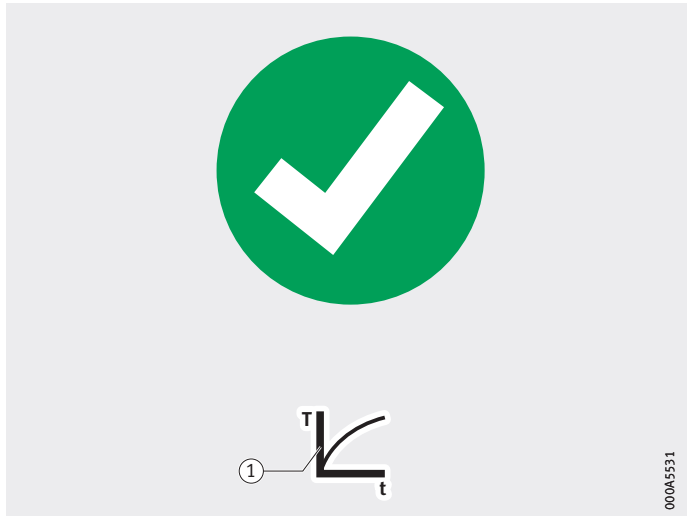

- Insert the USB stick in the USB connector.
- Click on the symbol [Save file].
- Confirm the suggested filename by clicking on the symbol [Apply], *Figure 53*.
- ▷ The values from the heating curve will be saved as a file on the USB stick.

① Symbol [Save file]
② Symbol [Apply]

Figure 53
Saving the heating curve

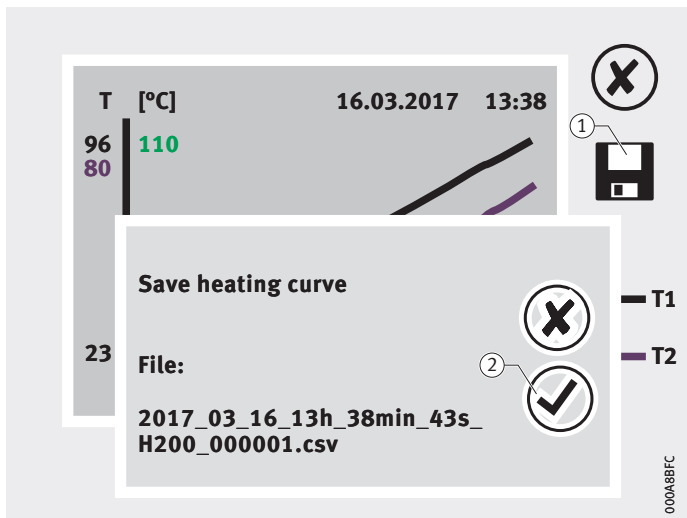

Troubleshooting

A malfunction of the heating operation may have many causes. Some errors can be identified by the user from the behaviour of the heating device but an error number is not displayed.

Other errors are identified by the heating device. The heating device will then display a corresponding error number and the associated error message on the touch-sensitive screen.

General errors

General errors are not displayed as an error message on the touch-sensitive screen, see *table*.

Error, cause, remedy

Error	Possible cause	Remedy
Date is not current and is displayed in red	<ul style="list-style-type: none">■ Battery empty■ If the heating device has not been used for approx. two weeks, the battery will have discharged itself	Connect the heating device to the voltage supply for several hours
During heating, the heating device emits strong vibrations	<ul style="list-style-type: none">■ Contact surfaces between the U-shaped core and ledge are not greased or insufficiently greased	Grease the contact surfaces between the U-shaped core and the ledge

Slight error

If an error message is displayed in a window with a grey background, the error can in most cases be remedied by the user, *Figure 54*.

- ▶ Eliminate the error.
- ▶ Restart heating device.

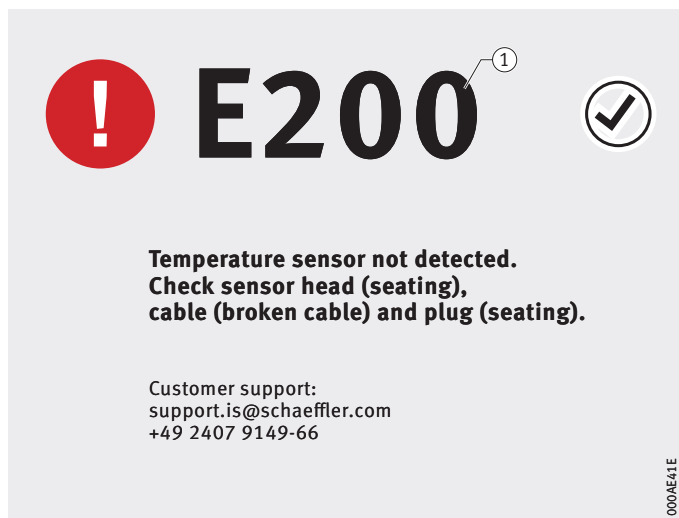

Induction heating devices HEATER

- Serious error** Some errors are displayed in a window with a red background, *Figure 55*. These errors cannot be remedied by the user.
- ▶ Make a note of the error number.
 - ▶ Contact Customer Service at Schaeffler Technologies AG & Co. KG.

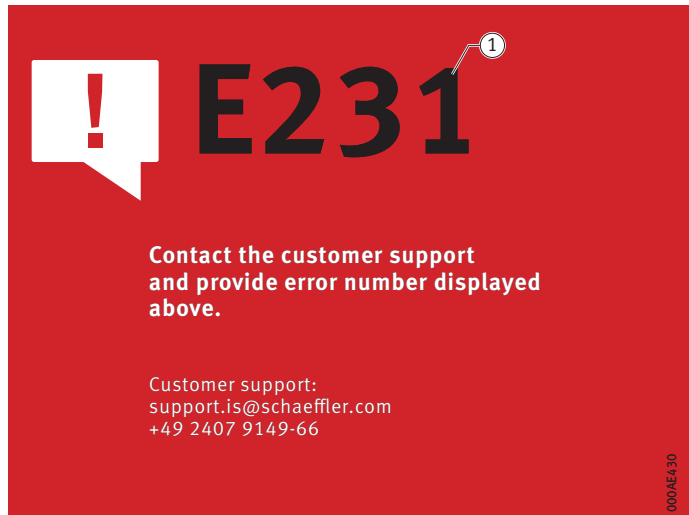

① Error number

Figure 55
Serious error,
red background

Repair

The heating device can be returned to Schaeffler Technologies AG & Co. KG for repair. In the case of smaller devices, an employee from Customer Service may be able to repair the device on site.



The heating device may operate incorrectly in a manner that is fatal if it is not repaired correctly.

A heating device may only be repaired by Schaeffler Technologies. <

Maintenance Before every use, a visual and functional inspection must be carried out. If necessary, maintenance must be carried out on the device.

Maintenance plan The maintenance items are stated in the maintenance plan, see *tables*.

Before every use

Subassembly	Activity
Heating device	Visual inspection: <ul style="list-style-type: none"> ■ Check the housing for damage ■ Check the plug and cable for damage to the insulation ■ Check that the sliding table and the support, slewing and vertical ledges are present and free from damage ■ Check the function of the display

As necessary

Subassembly	Activity
Heating device	<ul style="list-style-type: none"> ■ Clean with a soft, dry cloth
Contact surfaces on U-shaped core	<ul style="list-style-type: none"> ■ Cleaning of contact surfaces ■ For optimum contact and to prevent corrosion, regularly grease with an acid-free grease, see label LUBRICATE CONTACT SURFACES

Induction heating devices HEATER

Decommissioning If the heating device will no longer be used regularly, it should be decommissioned.

Decommissioning:

- ▶ Switch off the heating device using the main switch.
- ▶ Disconnect the heating device from the voltage supply.
- ▶ Fit the cover to the heating device.

Disposal The device can be returned to Schaeffler for disposal.
The heating device can be dismantled in order to dispose of the subassemblies separately.
The heating device may only be dismantled by an electrician.



Electrocution due to sudden discharge of capacitors.
Before dismantling of the heating device, wait at least 24 h after disconnection from the voltage supply. <



Cutting injuries to the hands when working on sharp-edged components located in the interior of the heating device.
In dismantling, use cut-resistant safety gloves. <

Regulations Disposal must be carried out in accordance with locally applicable regulations.

Technical data and accessories

Standard accessories are included in the scope of delivery, special accessories can be ordered separately.

HEATER25

Technical data and accessories for HEATER25, see *tables*.

Technical data

Designation	Value
Dimensions	465 mm×220 mm×275 mm
Mass without ledge	16 kg
Voltage supply	AC 230 V
Frequency	50 Hz
Power consumption	2,3 kVA
Current rating	10 A
Residual magnetism, maximum	2 A/cm
IP protection class	54
Mains connection cable	3 strands, length 1,5 m, rigidly connected to heating device
Mains connection plug	Safety contact plug to CEE-7

Standard accessories

Component	Designation	Dimension mm	d ¹⁾ mm	Mass kg
Support ledge	HEATER50.LEDGE-55²⁾	40×38×200	55	2,3
Temperature sensor	HEATER.SENSOR-500MM	–	–	0,05
Lifting tool	HEATER50.CARRY²⁾	–	–	0,35
Gloves	–	–	–	0,2
Grease	ARCANOL-MULTI3-250G	–	–	0,28

1) Suitable for rolling bearings with minimum inside diameter as stated.

2) Designation deviates from the naming system as the component is also used for HEATER50.

Special accessories

Component	Designation	Dimension mm	d ¹⁾ mm	Mass kg
Sliding table	HEATER50.SLIDING-TABLE²⁾	350×180×180	–	0,7
Support ledge	HEATER50.LEDGE-10²⁾	7×7×200	10	0,1
	HEATER50.LEDGE-15²⁾	10×10×200	15	0,2
	HEATER50.LEDGE-20²⁾	14×14×200	20	0,3
	HEATER50.LEDGE-35²⁾	25×24×200	35	0,9
Adapter posts	HEATER50.ADAPTER-75²⁾	40×50×75	–	2,2

1) Suitable for rolling bearings with minimum inside diameter as stated.

2) Designation deviates from the naming system as the component is also used for HEATER50.

Induction heating devices HEATER

HEATER50 Technical data and accessories for HEATER50, see *tables*.

Technical data

Designation	Value
Dimensions	450 mm×225 mm×260 mm
Mass without ledge	18 kg
Voltage supply	AC 230 V
Frequency	50 Hz
Power consumption	3 kVA
Current rating	13 A
Residual magnetism, maximum	2 A/cm
IP protection class	54
Mains connection cable	3 strands, length 1,5 m, rigidly connected to heating device
Mains connection plug	Safety contact plug to CEE-7

Standard accessories

Component	Designation	Dimension mm	d ¹⁾ mm	Mass kg
Support ledge	HEATER50.LEDGE-55	40×38×200	55	2,3
Temperature sensor	HEATER.SENSOR-500MM	–	–	0,05
Lifting tool	HEATER50.CARRY	–	–	0,35
Gloves	–	–	–	0,2
Grease	ARCANOL-MULTI3-250G	–	–	0,28

¹⁾ Suitable for rolling bearings with minimum inside diameter as stated.

Special accessories

Component	Designation	Dimension mm	d ¹⁾ mm	Mass kg
Support ledge	HEATER50.LEDGE-10	7×7×200	10	0,1
	HEATER50.LEDGE-15	10×10×200	15	0,2
	HEATER50.LEDGE-20	14×14×200	20	0,3
	HEATER50.LEDGE-35	25×24×200	35	0,9
Adapter posts	HEATER50.ADAPTER-75	40×50×75	–	2,2

¹⁾ Suitable for rolling bearings with minimum inside diameter as stated.

HEATER100 Technical data and accessories for HEATER100, see *tables*.

Technical data

Designation	Value
Dimensions	540 mm×227 mm×310 mm
Mass without ledge	35 kg
Voltage supply	AC 230 V
Frequency	50 Hz
Power consumption	3,7 kVA
Current rating	16 A
Residual magnetism, maximum	2 A/cm
IP protection class	54
Mains connection cable	3 strands, length 1,5 m, rigidly connected to heating device
Mains connection plug	Safety contact plug to CEE-7

Standard accessories

Component	Designation	Dimension mm	d ¹⁾ mm	Mass kg
Slewing ledge	HEATER100.LEDGE-70	50×48×280	70	5,6
Temperature sensor	HEATER.SENSOR-500MM	–	–	0,05
Lifting tool	HEATER100.CARRY	–	–	0,48
Gloves	–	–	–	0,2
Grease	ARCANOL-MULTI3-250G	–	–	0,05

¹⁾ Suitable for rolling bearings with minimum inside diameter as stated.

Special accessories

Component	Designation	Dimension mm	d ¹⁾ mm	Mass kg
Support ledge	HEATER100.LEDGE-15	10×10×280	15	0,2
	HEATER100.LEDGE-20	14×14×280	20	0,4
	HEATER100.LEDGE-35	25×24×280	35	1,8
Slewing ledge	HEATER100.LEDGE-55	40×38×280	55	3,7
Adapter posts	HEATER100.ADAPTER-120	50×62×120	–	4,7

¹⁾ Suitable for rolling bearings with minimum inside diameter as stated.

Induction heating devices HEATER

HEATER200 Technical data and accessories for HEATER200, see *tables*.

Technical data

Designation	Value
Dimensions	695 mm×330 mm×370 mm
Mass without ledge	86 kg
Voltage supply	AC 400 V
Frequency	50 Hz
Power consumption	8 kVA
Current rating	20 A
Residual magnetism, maximum	2 A/cm
IP protection class	54
Mains connection cable	5 strands, length 3,5 m, rigidly connected to heating device
Mains connection plug	5-pin three-phase plug to CEE-3P+N+E-32A

Standard accessories

Component	Designation	Dimension mm	d ¹⁾ mm	Mass kg
Slewing ledge	HEATER200.LEDGE-100	70×70×350	100	13,9
Temperature sensor	HEATER.SENSOR-1000MM	–	–	0,05
Lifting tool	HEATER200.CARRY	–	–	0,5
Gloves	–	–	–	0,2
Grease	ARCANOL-MULTI3-250G	–	–	0,28

¹⁾ Suitable for rolling bearings with minimum inside diameter as stated.

Special accessories

Component	Designation	Dimension mm	d ¹⁾ mm	Mass kg
Support ledge	HEATER200.LEDGE-20	14×14×350	20	0,5
Slewing ledge	HEATER200.LEDGE-30	20×20×350	30	2
	HEATER200.LEDGE-40	30×26×350	40	3,2
	HEATER200.LEDGE-55	40×38×350	55	5
	HEATER200.LEDGE-70	50×48×350	70	7,4
	HEATER200.LEDGE-85	60×60×350	85	10,4
Adapter posts	HEATER200.ADAPTER-150	70×80×150	–	11,4

¹⁾ Suitable for rolling bearings with minimum inside diameter as stated.

HEATER400 Technical data and accessories for HEATER400, see tables.

Technical data

Designation	Value
Dimensions	850 mm×420 mm×950 mm
Mass without ledge	157 kg
Voltage supply	AC 400 V
Frequency	50 Hz
Power consumption	12,8 kVA
Current rating	32 A
Residual magnetism, maximum	2 A/cm
IP protection class	54
Mains connection cable	5 strands, length 3,5 m, rigidly connected to heating device
Mains connection plug	5-pin three-phase plug to CEE-3P+N+E-32A

Standard accessories

Component	Designation	Dimension mm	d ¹⁾ mm	Mass kg
Vertical ledge	HEATER400.LEDGE-120	80×92×490	120	28,5
Temperature sensor	HEATER.SENSOR-1000MM	–	–	0,05
Gloves	–	–	–	0,2
Grease	ARCANOL-MULTI3-250G	–	–	0,28

¹⁾ Suitable for rolling bearings with minimum inside diameter as stated.

Special accessories

Component	Designation	Dimension mm	d ¹⁾ mm	Mass kg
Vertical ledge	HEATER400.LEDGE-40	20×32×490	40	4
	HEATER400.LEDGE-50	30×38×490	50	6,1
	HEATER400.LEDGE-65	40×50×490	65	9
	HEATER400.LEDGE-80	50×60×490	80	12,8
	HEATER400.LEDGE-90	60×72×490	90	17,4
	HEATER400.LEDGE-105	70×82×490	105	22,6

¹⁾ Suitable for rolling bearings with minimum inside diameter as stated.

Induction heating devices HEATER

HEATER800 Technical data and accessories for HEATER800, see *tables*.

Technical data

Designation	Value
Dimensions	1 080 mm×500 mm×1 250 mm
Mass without ledge	280 kg
Voltage supply	AC 400 V
Frequency	50 Hz
Power consumption	25,2 kVA
Current rating	63 A
Residual magnetism, maximum	2 A/cm
IP protection class	54
Mains connection cable	5 strands, length 3,5 m, rigidly connected to heating device
Mains connection plug	5-pin three-phase plug to CEE-3P+N+E-64A

Standard accessories

Component	Designation	Dimension mm	d ¹⁾ mm	Mass kg
Vertical ledge	HEATER800.LEDGE-150	100×112×750	150	65,9
Temperature sensor	HEATER.SENSOR-1500MM	–	–	0,05
Gloves	–	–	–	0,2
Grease	ARCANOL-MULTI3-250G	–	–	0,28

¹⁾ Suitable for rolling bearings with minimum inside diameter as stated.

Special accessories

Component	Designation	Dimension mm	d ¹⁾ mm	Mass kg
Vertical ledge	HEATER800.LEDGE-50	30×38×750	50	7,4
	HEATER800.LEDGE-65	40×50×750	65	12,2
	HEATER800.LEDGE-80	50×60×750	80	18,3
	HEATER800.LEDGE-90	60×72×750	90	25,4
	HEATER800.LEDGE-105	70×82×750	105	33,8
	HEATER800.LEDGE-120	80×92×750	120	43,3
	HEATER800.LEDGE-135	90×102×750	135	54

¹⁾ Suitable for rolling bearings with minimum inside diameter as stated.

HEATER1600 Technical data and accessories for HEATER1600, see tables.

Technical data

Designation	Value
Dimensions	1 500 mm×800 mm×1 600 mm
Mass without ledge	650 kg
Voltage supply	AC 400 V
Frequency	50 Hz
Power consumption	40 kVA
Current rating	100 A
Residual magnetism, maximum	2 A/cm
IP protection class	54
Mains connection cable	3 strands, minimum cross-section 35 mm ²
Mains connection plug	–
Fuse protection	3NA3 830 NH000 500VAC 100A

Standard accessories

Component	Designation	Dimension mm	d ¹⁾ mm	Mass kg
Vertical ledge	HEATER1600.LEDGE-220	150×162×1080	220	206,1
Temperature sensor	HEATER.SENSOR-1500MM	–	–	0,05
Gloves	–	–	–	0,2
Grease	ARCANOL-MULTI3-250G	–	–	0,28

¹⁾ Suitable for rolling bearings with minimum inside diameter as stated.

Special accessories

Component	Designation	Dimension mm	d ¹⁾ mm	Mass kg
Vertical ledge	HEATER1600.LEDGE-90	60×72×1080	90	36,6
	HEATER1600.LEDGE-120	80×92×1080	120	62,4
	HEATER1600.LEDGE-150	100×112×1080	150	94,9

¹⁾ Suitable for rolling bearings with minimum inside diameter as stated.

Original accessories

Only use FAG original accessories.

Induction heating devices HEATER

Appendix This appendix contains the Declaration of Conformity for heating devices.

EC Declaration of Conformity Declaration of Conformity for heating devices HEATER25, HEATER50, HEATER100, HEATER200, HEATER400, HEATER800 and HEATER1600, Figure 56.

SCHAEFFLER

EC Declaration of Conformity
in accordance with Low Voltage Directive 2014/35/EU
and RoHS Directive 2011/65/EU
and Machinery Directive 2006/42/EG

The manufacturer: Schaeffler Technologies AG & Co. KG
Georg-Schäfer-Straße 30
D-97421 Schweinfurt

hereby declares that the product described below is in conformity with the applicable health and safety requirements of following EC Directives: Low Voltage Directive 2014/35/EU, RoHS Directive 2011/65/EU and Machinery Directive 2006/42/EG in terms of its design and type and in the execution the manufacturer has brought into circulation. This declaration shall cease to be valid if any modification is made to the product without the agreement of the manufacturer.

The sole responsibility for the issuing of this declaration of conformity is within the charge of the manufacturer.

Product description: Inductive Heating Device
Product name: HEATER
Type: 25 to 1600

Applicable harmonized standards:

EN-ISO 12100:2010:	Safety of Machinery - General principles for design: Risk Assessment & Risk Reduction
EN 60204-1:2006+A1:2009+AC :2010:	Safety of machinery - Electrical equipment of machines - Part 1: General requirements
EN 50110-1:2014:	Operation of electrical installations - Part 1: General requirements

Further applicable standards:

NEN 3140 + A1:2015:	Operation of electrical installations - Low voltage
---------------------	---

Name and address of the authorized person for the technical documentation:
Schaeffler Technologies AG & Co. KG
Georg-Schäfer-Straße 30
D-97421 Schweinfurt

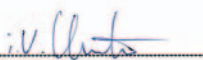
Peter Schuster
Department Manager Mechatronic

Place, Date:
Schweinfurt, 14.05.2019

This declaration certifies conformity with the stated directives but does not represent a guarantee of characteristics. The safety guidelines in the user manual must be observed.

Schaeffler Technologies AG & Co. KG • Georg-Schäfer-Straße 30 • D-97421 Schweinfurt • Tel.: +49 9721 91-0

000C972B

Figure 56
Declaration of Conformity

Schaeffler Technologies AG & Co. KG

Georg-Schäfer-Straße 30

97421 Schweinfurt

Germany

www.schaeffler.de/en/services

Technical support:

www.schaeffler.de/en/technical-support

All information has been carefully compiled and checked by us, but we cannot guarantee complete accuracy. We reserve the right to make corrections. Therefore, please always check whether more up-to-date or amended information is available. This publication supersedes all deviating information from older publications. Printing, including excerpts, is only permitted with our approval.
© Schaeffler Technologies AG & Co. KG
BA 42 / 05 / en-GB / DE / 2022-01